



© Kym

© Joly Pics

© Agence Zoom

WAX

2024 - 2025

THE WAX MADE IN FRANCE SINCE 1935

VOLA RACING



FLY TO SUCCESS

30 YEARS OF STORIES & PODIUMS

Depuis 1935 nous concevons des farts pour apporter de meilleures sensations et de meilleures performances à chacun. Chaque fart est conçu, fabriqué et emballé en France, au pied du Mont-Blanc à Passy. La passion du ski et l'innovation sont des valeurs-motrices, transmises de génération en génération dans l'entreprise.

Since 1935 we have created waxes to bring better sensations and better performances to everyone. Each wax is designed, cast and packed in France, at the foot of the Mont Blanc in Passy. The passion of skiing and the innovation are our values that we are transferring from generation to generation in the company.

ADVICE ————— Pages 04-19

WAX ————— Pages 20-49

ACCESSORIES ————— Pages 50-69

EQUIPMENT ————— Other side of the catalogue

   @volaracing_sports

× 3 ×





ADVICE

— CONSEILS —

NEW
Mise à jour / Update

VOLA Advice

Easy To Use Helpfull 100% Fun

Entrez vos données (niveau, météo, type de neige, etc.) et un choix de fartage vous sera proposé!

Enter your data (level, weather, type of snow, etc.) and you'll be offered a choice of waxes!

Retrouvez tous les tutoriels dans l'onglet Vidéo
Find all the tutorials in the Video tab

VolaAdvice est une plateforme de conseils pour affûter et farter son matériel. VolaAdvice vous suit au quotidien pour une meilleure glisse et de meilleures performances. Rendez-vous sur www.vola.fr

VolaAdvice is an advice platform for sharpening and waxing your equipment. VolaAdvice follows you on a daily basis for better gliding and better performance. Go on www.vola.fr



Alpine Nordic Snowboard



EMBARQUEZ DANS L'AVENTURE

Scannez les QR Codes & découvrez les vidéos!
Puis, rendez-vous sur les autres plateformes pour visionner
l'intégralité des tutoriels.

EMBARK ON THE ADVENTURE

Scan the QR Codes & discover the videos!
Then, go to the other platforms to view the full tutorials.



vola.fr

YouTube

VOLA Advice

Les fondamentaux / Foundations

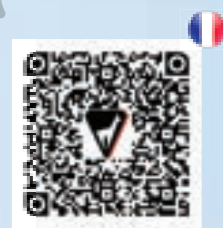

Affûter avec une lime / Sharpening with a file

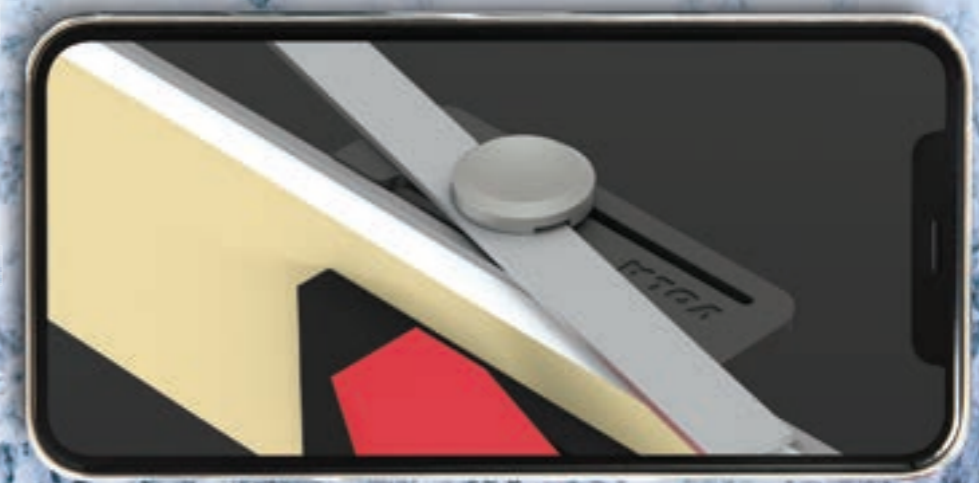

Appliquer un fart solide / Apply a solid wax

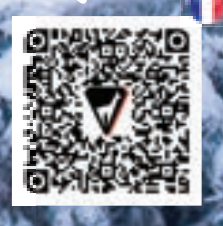
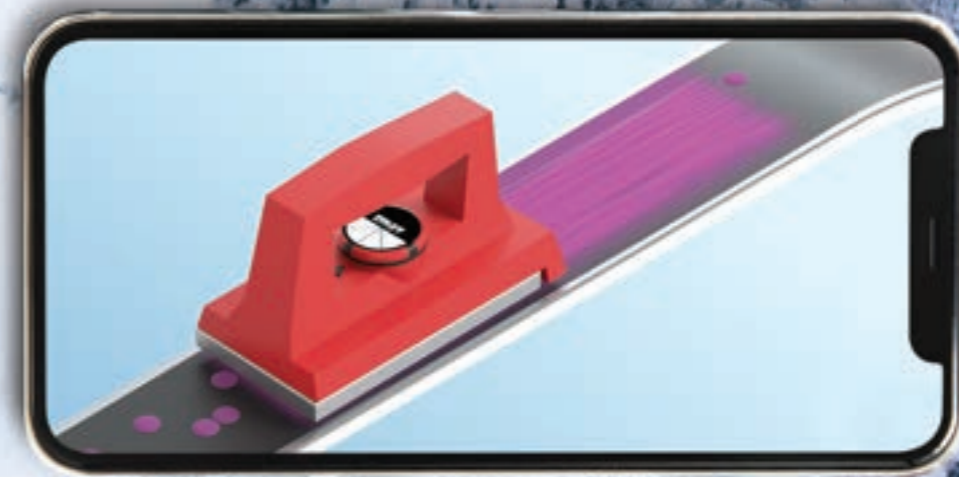





CARE WAXES

Farts d'entretien

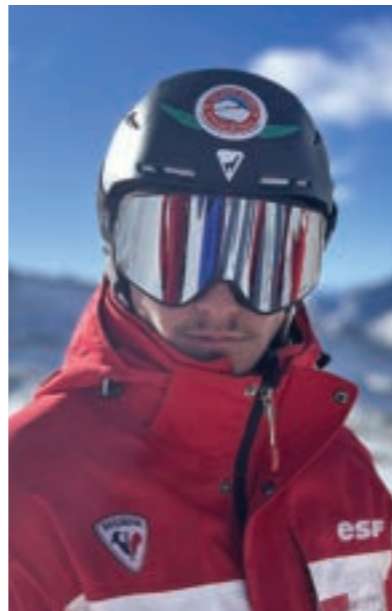
No Fluor APPROVED



 VOLA développe et propose des farts bio-sourcés depuis le lancement de l'Ewax, il y a plus de 10 ans. Nous mettons tout en oeuvre pour offrir aux skieurs exigeants des gammes de farts plus soucieuses de l'homme et de l'environnement, avec des performances comparables à des farts à base d'hydrocarbures classiques. Sans fluor, ces farts intègrent jusqu'à 100% de matières premières d'origine naturelle. Les versions liquides de ces farts utilisent un solvant alternatif et ne sont pas classés comme produits dangereux, permettant ainsi une application simple et en toute sécurité.

 VOLA has been developing and offering bio-based waxes since the launch of Ewax, more than 10 years ago. We do our utmost to offer demanding skiers a range of waxes that are more respectful of people and the environment, with performances comparable to those of conventional hydrocarbon-based waxes. These fluorine-free waxes contain up to 100% natural raw materials. The liquid versions of these waxes use an alternative solvent and are not classified as hazardous, allowing safe and easy application.

 VOLA entwickelt und verkauft Waxe aus biologischer Herkunft seit die Einführung unseres E-wax, vor mehr als 10 Jahre. Wir setzen alles daran um den anspruchsvollen Skifahrer Umweltfreundlichere Produkte (ohne Fluor) anzubieten, mit gleichwertigen Leistungen als von den klassischen Kohlenwasserstoffen basierende Waxe. Ganz ohne Fluor, enthalten diese Waxe bis zu 100% der Rohstoffe aus natürlichen Ursprung. Die flüssige Version dieser Waxe enthalten ein alternatives Lösemittel und werden nicht als Gefahrgut betrachtet, was eine einfache und sichere Anwendung ermöglicht.



× 8 ×



Ewax



UNIVERSAL WAX



TOURING



MX-E

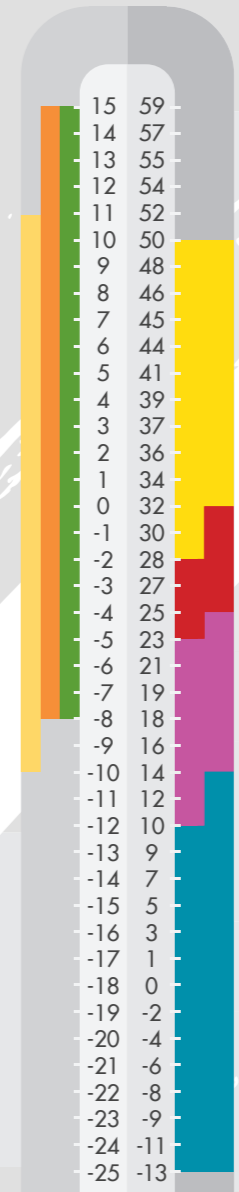

Air°C Air°F

THE WAX MADE IN FRANCE SINCE 1935

× 9 ×

RACING WAXES

Farts de course

No Fluor
APPROVED



TOP FINISH **M**RACE

MOLY > version pour neige vieillie et sale
version for old and dirty snow

HMRACE

HIGH ABRASION **NEW** info

MOLY > version pour neige vieillie et sale
version for old and dirty snow

LMRACE

LOW ABRASION **NEW** info

MOLY > version pour neige vieillie et sale
version for old and dirty snow

MX-E

BASES

WORK RACE WIN REPEAT

VOLA
RACING



LET'S EXPLORE OUR WEBSITE

vola.fr

MOLYBDEN



Le molybdène est un composé chimique avec des propriétés hydrophobes très intéressantes sur certains types de neige comme les neiges dites anciennes (avec des cristaux de neige érodés). Les additifs au molybdène placés dans les farts VOLA offrent de très bonnes performances dans les conditions de neige à grains transformés avec un fort coefficient de friction (neiges artificielles, gros sel, gelées, sales). Sa consistance grasse lui procure un fort pouvoir de lubrification tout en permettant de repousser la saleté et la pollution. Nécessite l'utilisation de la brosse acier ultra fin (fine steel) après raclage.



Molybden is a chemical compound with hydrophobic properties very interesting on certain types of snow like old snow (with snow crystals eroded). The molybden additives placed in VOLA waxes offer very good performance in snow conditions with transformed snow which has a high coefficient of friction (artificial snow, frozen, dirty). His greasy consistency gives him a strong lubricity while allowing repel dirt and pollution. Requires the use of ultra fine steel brush (fine steel) after scraping.



Molybdän ist ein Gleitmittel und besteht aus Wasserabweisende chemischen Produkte die äusserst gut auf alten Schneearten gleiten (mit erodierte Schneekristalle). Die Molybdän Additive in den VOLA Produkten bieten sehr gute Leistungen auf Wiedergefrorenen Schnee mit starkem Reibungskoeffizient (Kunstschnee, Steinsalz, gefrorenen, gesalzener). Seine fettige Konsistenz beschafft ihn mit starker Schmierwirkung und folglich Verschmutzungsabweisend. Erfordert die Verwendung der microstahl Bürste nach dem abziehen des Waxes.



Il molibdeno è un composto chimico con proprietà idrofobiche molto interessanti su alcuni tipi di neve, come la neve vecchia dicendo (con cristalli di neve erosi). Gli additivi molibdeno collocati nelle cere VOLA offrono ottime prestazioni in condizioni di neve trasformata con un alto coefficiente di attrito (neve artificiale, sale, congelati, sporchi) chicchi. La sua consistenza grassa gli dà un forte potere lubrificante, consentendo respingere lo sporco e l'inquinamento. Richiede l'uso di spazzole in acciaio ultra fine (acciaio fine) dopo la raschiatura.

GRAPHITE



Les farts graphites sont destinés aux semelles graphitées. Toutes les semelles de ski de couleur noire sont graphitées. Ces semelles, après plusieurs utilisations, perdent leur charge en graphite et donc la capacité hydrophobique est diminuée. Faire un fartage avec un fart graphite va alors recharger la semelle. Ces farts sont à utiliser tous les 7 à 10 fartages pour recharger une semelle. Les bases graphitées sont utilisées régulièrement grâce au pouvoir lubrifiant du graphite sur des neiges spécifiques. À éviter sur neige fraîche.



Graphite waxes are for graphitized bases. All ski bases black are graphitized. These bases, after several uses, lose their charge in graphite and therefore the hydrophobic capacity is diminished. Make a waxing with a graphite wax will reload the base. These waxes are used every 7-10 waxing to recharge the base. The graphite bases are used regularly thanks to the lubricity of graphite on specific snow. Avoid on fresh snow.



Die Graphitwaxe sind für Graphitbeläge vorgesehen. Alle schwarze Skibeläge sind graphitiert. Nach mehreren Benutzungen, verlieren diese Beläge deren Graphit-Lastung und damit deren Hydrophobischen Eigenschaften. Das Waxen mit Graphitwax wird der Belag entsprechend wieder aufladen. Diese Waxe sollten alle 7 bis 10 Waxen aufgetragen werden. Die Graphit-Basis werden regelmässig benutzt dank deren Schmierfähigkeit auf spezifischen Schneearten. Hat keinen Einfluss auf frischen Schneearten. Auf Neuschnee zu vermeiden.



Gli sioline grafite sono per soles grafitato. Tutte le solette nero sono grafitato. Queste soles, dopo vari utilizzi, perdono la loro carica in grafite e quindi la capacità idrofobo è diminuita. Fare una cera con grafite cera quindi ricaricare la suola. Queste cere vengono utilizzati ogni 7-10 ceretta per ricaricare la suola. Le basi di grafite vengono utilizzati regolarmente attraverso il potere lubrificante della grafite sulla neve specifico. Evitare sulla neve fresca.

ENTRAINEMENT / TRAINING

U12 ▶ MX-E Solid



U14 ▶ MX 901 + MX-E Liquid



PRO ▶ MX 901 + BASE



Selon la discipline / According to the discipline



A STORY



Où tout a commencé: le magasin de sports à Colmar en 1935
Where it all started: the sports store in Colmar in 1935



L'entreprise quitte Colmar et s'installe à Passy, en Haute-Savoie
The company leaves Colmar and settles in Passy, in Haute-Savoie



Travailler au pied du Mont-Blanc, ça n'a pas de prix !
Working at the foot of Mont-Blanc is priceless !



Avril/April 1966, Megève

Une passion du ski qui se transmet de génération en génération
A passion for skiing transmitted from generation to generation



Le «shooting» du premier livret technique
The «shooting» of the first technical booklet



Une production artisanale et Française depuis toujours
An artisanal and French production since always



Tests de fartage avec les plus grands skieurs tel que A. Duvillard
Waxing tests with famous skiers like A. Duvillard



Une ambiance conviviale
A friendly atmosphere



Des produits qui ne cessent d'innover
Products that keep innovating



An international vision:
Vola at the Winter Park slalom, Colorado



Toujours avec le plaisir de transmettre notre savoir-faire
Always with the pleasure of transmitting our know-how



Vola a participé au salon ISPO depuis le début
Vola has participated in ISPO since the beginning



1988 / Tests de glisse au Tour à Chamonix
1988 / Gliding tests at the Tour in Chamonix



Démonstration de fartage et d'affûtage en mai 1989
Waxing and sharpening demonstration, May 1989



EST. 2018
VOLA
ROCKET
Team

D'année en année,
 vous nous faites vibrer.
 Suivez les aventures
 de ces athlètes
 hors du commun.
#rocketteam

FLY TO
 SUCCESS

PARTNER

OF NATIONAL SKI TEAMS



@volaracing_sports
 @ f o

VOLA RACING

vola.fr

A brand for all mountain lovers.

Beginners, experts, competitors, skiers, snowboarders, free-skiers, telemarkers, aplinists, stores, pro, France, world... In short, for anyone who loves the outdoors, freedom, sensation, adrenalin, beauty, powder, slopes and everything else in between.

HELMETS
 FIS
 Soudal

GOGGLES
 Wiley's
 FAST
 INNOVITY
 Zippy

POLES

BASE LAYERS
 UNDERWEAR
 Collections

WAXES & TOOLS

CARE PRODUCTS
 ECO TEXTILE CARE

© Agence Zoom



Merci beaucoup,
de partager votre passion avec nous

....

Thank you very much,
for sharing your passion with us



 @volaracing_sports

× 18 ×

🇫🇷 La famille

Du débutant à l'expert, du snowboarder au freestyler, en passant par le fondeur, tous les amoureux de la montagne font parti de notre famille. Une famille friande de liberté, de grands espaces et d'or blanc. L'hiver, c'est notre passion et nous aimons la partager.

Les jours passent mais ne se ressemblent pas. Des champs de poudreuse au slalom verglacé, notre team d'accros à la neige nous fait vivre de nombreuses aventures!

Nos réseaux sociaux sont remplis de sourires, de joie de vivre et d'adrénaline grâce à toutes ces personnes engagées dans la communauté. Avec eux, nous parcourons le monde, explorons des contrées reculées et respirons l'air pur des montagnes immaculées. Ils nous font rire, ils nous font pleurer mais quoi qu'il en soit, nous adorons vivre ce quotidien avec eux.

Si ce n'est pas encore fait, ne tardez plus et embarquez dans l'aventure.

@volaracing_sports
#volaracing

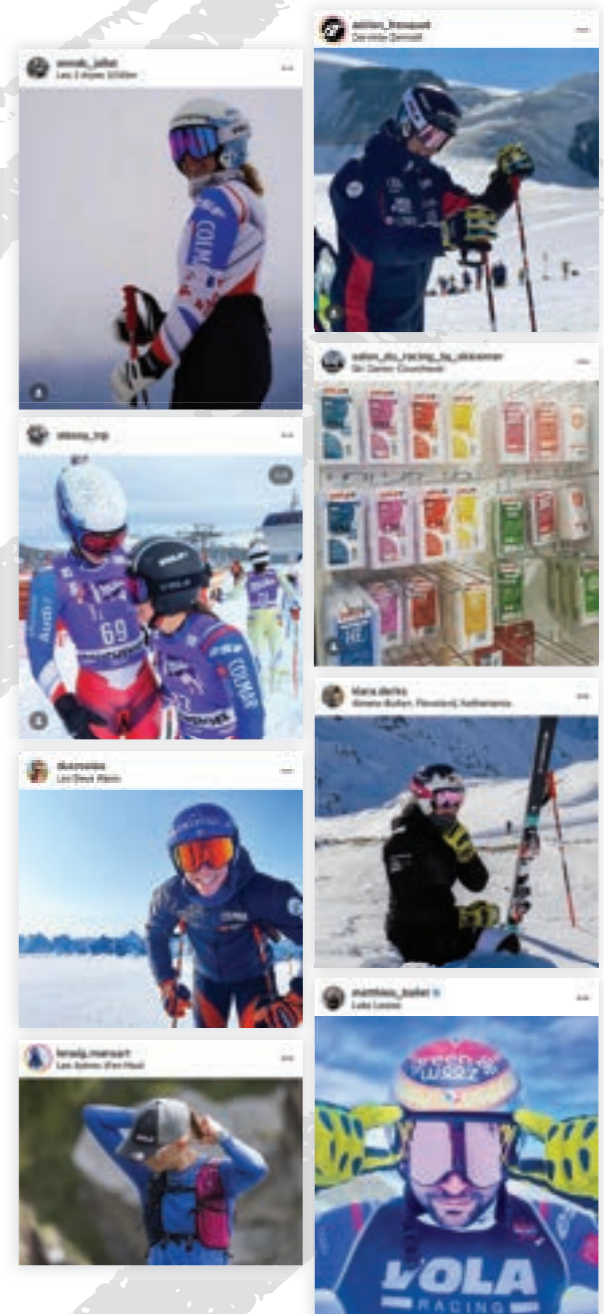
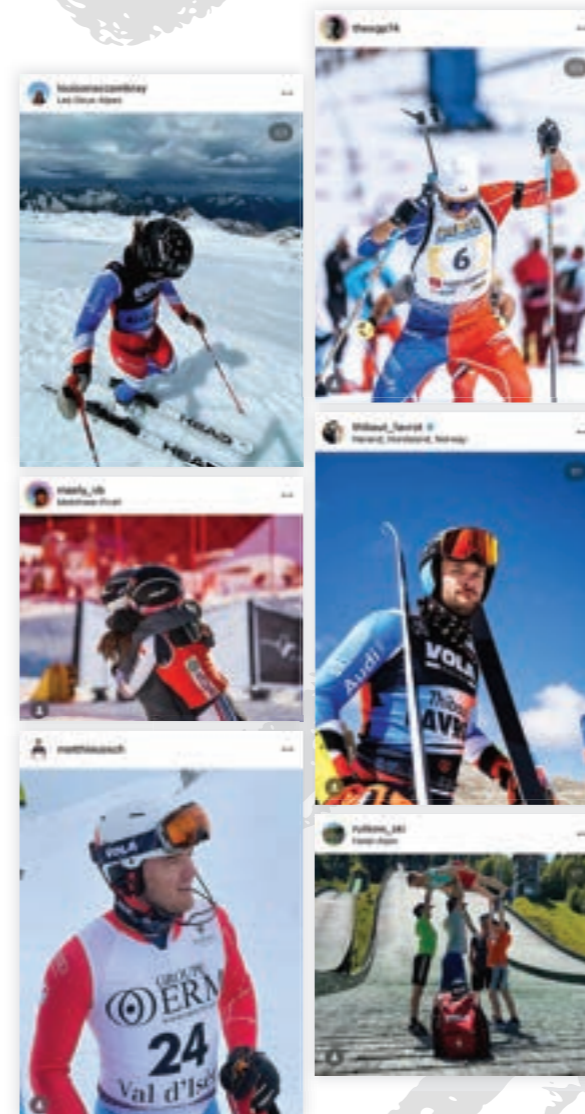

🇬🇧 The family

From beginner to expert, freestyle snowboarder to ski racer, we are all mountain lovers and are all part of the family.

Winter is our passion, mountain freedom, wide open spaces and the white gold. Without noticing, days pass either in the powder fields or on the icy slalom pistes, our team of snow addicts help us live many adventures.

Our social networks are filled with peoples' smiles, joys and adrenaline filled lives. With them we travel the world and together lets' explore the mountains breathing pristine clean air. They make us laugh, they make us cry, but whatever it is we love to live day to day with them.

If it hasn't been done yet, don't delay come and join this mountain adventure.

volaracing_sports
 volaracing

× 19 ×



NEW FORMULA *E Wax*

FLUOR FREE



▶ Page 22-23

UNI
UNIVERSAL WAX

No Fluor APPROVED



▶ Page 24-25

MX-E

No Fluor APPROVED



▶ Page 26-27

TOURING

No Fluor APPROVED



▶ Page 28-29

BASES

No Fluor APPROVED



▶ Page 30-33

RACE

No Fluor APPROVED



▶ Page 34-43

TOP FINISH RACE

No Fluor APPROVED



▶ Page 44-45

NORDIC CLASSIC WAX

No Fluor APPROVED



▶ Page 46-47

SKI WAX⁺
remover

No Fluor APPROVED



▶ Page 48-49

WAX



E-Wax

- FR** L' E-Wax est le premier fart bio-sourcé, développé par VOLA il y a déjà plus de 12 ans. L'E-Wax évolue, pour une application simplifiée sans compromis sur la glisse. Sans fluor, il intègre désormais 100% de matières premières d'origine naturelle. Son emballage 100% végétal est bio-dégradable et peut être composté. L'encre utilisée ne contient aucun métaux lourds. L' E-Wax conviendra parfaitement à tous les types de skieurs et à tous les ateliers de fartages. Il peut se crayonner ou s'appliquer à chaud.
- UK** E-Wax is the first bio-sourced wax, developed by VOLA more than 12 years ago. The E-Wax evolves, for a simplified application without compromise on the glide. Fluorine-free, it now contains 100% natural raw materials. Its 100% vegetable-based packaging is biodegradable and can be composted. The ink used does not contain any heavy metals. E-Wax is suitable for all types of skiers and waxing workshops. It can be pencilled or applied hot.
- DE** E-Wax ist das erste bio-basierte Wachs, das von VOLA vor mehr als 12 Jahren entwickelt wurde. Dieses Jahr wurde das E-Wax weiterentwickelt, um die Anwendung zu vereinfachen, ohne Kompromisse beim Gleiten einzugehen. Es enthält kein Fluor und besteht nun zu 100 % aus Rohstoffen natürlichen Ursprungs. Die zu 100 % pflanzliche Verpackung ist biologisch abbaubar und kann kompostiert werden. Die verwendete Tinte enthält keine Schwermetalle. Das E-Wax ist für alle Arten von Skifahrern und für alle Wachsworkstätten geeignet. Es kann mit Bleistift oder heiß aufgetragen werden.
- IT** E-Wax è la prima cera di origine biologica, sviluppata da VOLA più di 12 anni fa. L'E-Wax si evolve, per un'applicazione semplificata senza compromessi sulla scorrevolezza. Senza fluoro, ora contiene il 100% di materie prime naturali. Il suo imballaggio 100% vegetale è biodegradabile e può essere compostato. L'inchiostro utilizzato non contiene metalli pesanti. E-Wax è adatto a tutti i tipi di sciatori e ai laboratori di sciolinatura. Può essere scritto a penna o applicato a caldo.

FLUOR FREE 

NEW FORMULA

E-Wax

- #1/ Encore plus écologique
- #2/ Formule durcie
- #3/ Raclage et brossage optimisés
- #1/ Even more ecological
- #2/ Hardened formula
- #3/ Optimized scraping and brushing

Contient 100% de cires naturelles et bio-sourcées
Contains 100% of natural and bio-sourced waxes

 115°C / 239°F



Fabriqué en / Made in France!

Encre à l'eau sans métaux lourds
Water-based ink without heavy metals

Foile de jute / Burlap packaging 100% végétal

AIR = -10°C > 10°C / 14°F > 50°F

- REF. 522604 **60ml**
- REF. 522005 **80g**
- REF. 522400 **80 pcs x 30g**
- REF. 522100 **200g**
- REF. 522200 **500g**
- REF. 522405 **10kg**



Le saviez-vous?
Vola travail depuis 2009 sur la formule E-Wax. Plus d'une décennie pour vous offrir un fart performant et respectueux de l'environnement !

Did you know that?
Vola has been working since 2009 on the E-Wax formula. More than a decade to offer you a high performance and environmentally friendly wax!



AIR -8°C > 15°C / 18°F > 60°F

SOLID

- REF. 222400 **80 pcs x 30g**
- REF. 222004 **80g**
- REF. 222005 **13 pcs x 80g**
- REF. 222100 **200g**
- REF. 222200 **500g**
- REF. 222401 **5kg**
- REF. 222500 **12kg**

 100°C / 212°F



UNIVERSAL WAX

 Les farts VOLA "Universal" s'adressent à tous les skieurs, du débutant au confirmé, recherchant un fart polyvalent efficace sur tous les types de neiges. Selon le conditionnement ils s'adaptent à une utilisation personnelle ou en atelier. Ils participent efficacement à l'entretien des semelles des skis. Cette année, le fart Universal Liquide intègre un solvant alternatif et n'est plus classé comme produits dangereux, permettant un fartage plus respectueux de la santé et de l'environnement.

 VOLA «Universal» waxes are designed for all skiers, from beginners to advanced, looking for a versatile wax that is effective on all types of snow. Depending on the packaging, they are suitable for personal use or in the workshop. They contribute effectively to the maintenance of the skis' soles. This year, the Universal Liquid wax incorporates an alternative solvent and is no longer classified as a dangerous product, allowing a waxing that is more respectful of health and the environment.

 Die VOLA «Universal»-Wachse richten sich an alle Skifahrer, vom Anfänger bis zum Fortgeschrittenen, die ein vielseitiges Wachs suchen, das auf allen Schneearten wirksam ist. Je nach Verpackung eignen sie sich für den persönlichen Gebrauch oder für die Werkstatt. Sie tragen wirksam zur Pflege der Skilaufohlen bei. In diesem Jahr enthält das Wachs Universal Liquide ein alternatives Lösungsmittel und ist nicht mehr als Gefahrgut eingestuft, was ein gesundheits- und umweltfreundlicheres Wachsen ermöglicht.

 Le scioline VOLA «Universal» sono progettate per tutti gli sciatori, dai principianti agli esperti, che cercano una sciolina versatile ed efficace su tutti i tipi di neve. A seconda della confezione, sono adatti per uso personale o in officina. Contribuiscono efficacemente alla manutenzione delle soles degli sci. Quest'anno, la cera liquida universale incorpora un solvente alternativo e non è più classificata come prodotto pericoloso, permettendo una ceretta più rispettosa della salute e dell'ambiente.

LIQUID

- REF. 222604 **60ml**
- REF. 222614 **8 pcs x 60ml**
- REF. 222624 **18 pcs x 60ml**
- REF. 222704 **1L**
- REF. 222714 **5L**

CLEAN FORMULA

Sans pictogramme de danger :
Plus respectueux de la santé
et de l'environnement
No danger pictograms :
More respectful of health
and the environment



- REF. 222600 **75ml**  Dia=35mm / L=15.5cm
- REF. 222601 **250ml**  Dia=50mm / L=22.5cm







MX-E

RACING & ECOLOGICAL WAX

 Les farts MX-E ont été développés pour les skieurs à la recherche d'un fart plus écologique, sans compromis sur la performance. Cette gamme complète de 4 couleurs permet d'optimiser la glisse dans toutes conditions de neige, tout en nourrissant la semelle. Composés d'au moins 50% de matières bio-sourcées et sans fluor, les farts MX-E solides sont conditionnés en boîtes carton recyclables. Les farts MXE liquides sont quant à eux produits sur la base d'un solvant alternatif non classé dangereux, réduisant ainsi les risques pour la santé et l'environnement. VOLA a pris en compte toutes les étapes du cycle de vie pour proposer aux skieurs exigeants une gamme de farts écologiques égalant les performances des farts classiques à base d'hydrocarbures.

 MX-E waxes have been developed for skiers looking for a more environmentally friendly wax without compromising on performance. This complete range of 4 colours allows to optimize the glide in all snow conditions, while nourishing the sole. Composed of at least 50% bio-sourced materials and without fluorine, MX-E solid waxes are packaged in recyclable cardboard boxes. MX-E liquid waxes are produced using an alternative solvent that is not classified as dangerous, thus reducing the risks to health and the environment. VOLA has taken into account all stages of the life cycle to offer demanding skiers a range of ecological waxes that match the performance of traditional hydrocarbon-based waxes.

 Die MX-E-Wachse wurden für Skifahrer entwickelt, die ein umweltfreundlicheres Wachs suchen, ohne Kompromisse bei der Leistung einzugehen. Diese komplette Palette von 4 Farben optimiert das Gleiten bei allen Schneebedingungen und nährt gleichzeitig den Belag. Die festen MX-E-Wachse bestehen zu mindestens 50 % aus biobasierten Materialien und sind fluorfrei. Sie werden in recycelbaren Kartonschachteln verpackt. Die flüssigen MXE-Wachse werden mit einem alternativen Lösungsmittel hergestellt, das nicht als Gefährlich eingestuft wird, was ein gesundheits- und umweltfreundlicheres Wachsen ermöglicht. VOLA hat alle Phasen des Lebenszyklus berücksichtigt, um anspruchsvollen Skifahrern eine Reihe umweltfreundlicher Wachse anbieten zu können, die die Leistung herkömmlicher, auf Kohlenwasserstoff basierender Wachse erreichen.

 Le scioline MX-E sono state sviluppate per gli sciatori che cercano una sciolina più ecologica senza compromettere le prestazioni. Questa gamma completa di 4 colori permette di ottimizzare lo scivolamento in tutte le condizioni di neve, nutrendo la suola. Composte da almeno il 50% di materiali di origine biologica e senza fluoro, le cere solide MX-E sono confezionate in scatole di cartone riciclabili. Le cere liquide MX-E sono prodotte utilizzando un solvente alternativo che non è classificato come pericoloso, riducendo così i rischi per la salute e l'ambiente. VOLA ha preso in considerazione tutte le fasi del ciclo di vita per offrire agli sciatori esigenti una gamma di scioline ecologiche che eguagliano le prestazioni delle scioline tradizionali a base di idrocarburi.

MX-E BLUE

Air -25°C > -10°C / -13°F > 10°F

- REF 221911 **80g**
- REF 221911K **13 pcs x 80g**
- REF 221901 **200g**
- REF 221921 **500g**
- REF 221931 **5kg**
- REF 221941 **12kg**
- REF 221961 **60ml**
- REF 221971 **250ml**

 120°C / 248°F



MX-E PURPLE

Air -12°C > -4°C / 10°F > 25°F

- REF 221912 **80g**
- REF 221912K **13 pcs x 80g**
- REF 221902 **200g**
- REF 221922 **500g**
- REF 221932 **5kg**
- REF 221942 **12kg**
- REF 221962 **60ml**
- REF 221972 **250ml**

 115°C / 239°F



MX-E RED

Air -5°C > 0°C / 23°F > 32°F

- REF 221913 **80g**
- REF 221913K **13 pcs x 80g**
- REF 221903 **200g**
- REF 221923 **500g**
- REF 221933 **5kg**
- REF 221943 **12kg**
- REF 221963 **60ml**
- REF 221973 **250ml**

 110°C / 230°F



MX-E YELLOW

Air -2°C > 10°C / 28°F > 50°F

- REF 221914 **80g**
- REF 221914K **13 pcs x 80g**
- REF 221904 **200g**
- REF 221924 **500g**
- REF 221934 **5kg**
- REF 221944 **12kg**
- REF 221964 **60ml**
- REF 221974 **250ml**

 105°C / 212°F







TOURING

- 

Fart développé pour les passionnés de ski de randonnée recherchant la performance. De subtils mélanges ont permis à VOLA de développer un fart à chaud n'empêchant pas les peaux de phoque d'adhérer à la semelle. Pour les habitués, il peut également être crayonné sur les peaux en tant qu'anti-botte même si certains spécialistes préféreront mettre un fart liquide pour une utilisation plus facile.
- 

Wax developed for ski touring performance. Subtle blends allowed VOLA to develop a solid wax which is ideal for skins (the skins continue to stick to the base). For regulars, it can be rubbed on the skins as an anti-balling snow plate even if some experts prefer to put liquid for an easier use.
- 

Ein Wax das für Skitouren Enthusiasten entwickelt wurde, die nach mehr Leistung streben. Eine subtile Mischungen ermöglichte VOLA dieses heiss-Wax zu entwickeln der nichts an der Haftung der Felle auf dem Belag ändert. Für Kenner, kann es auch auf den Fellen eingetragen werden als anti-boot nützlichkeit, obwohl einige Experten dafür lieber die flüssige Variante benutzen für eine einfachere Anwendung.
- 

Sciolina sviluppato per gli appassionati che cercano prestazioni di sci alpinismo. Miscela sottile permesso VOLA sviluppare una sciolina che è ideale per le pelli. (non impedisce le bucce aderire alla suola.) Per abituali, può anche essere a matita sulla pelle come un anti-boot anche se alcuni esperti preferiscono mettere una cera liquida per uso più facile.



FART POUR LA RANDO' SKI TOURING WAX

- REF. 224505 **60ml**
- REF. 224504 **75ml**
- REF. 224502 **80g**
- REF. 224503 **200g**
- REF. 224501 **500g**



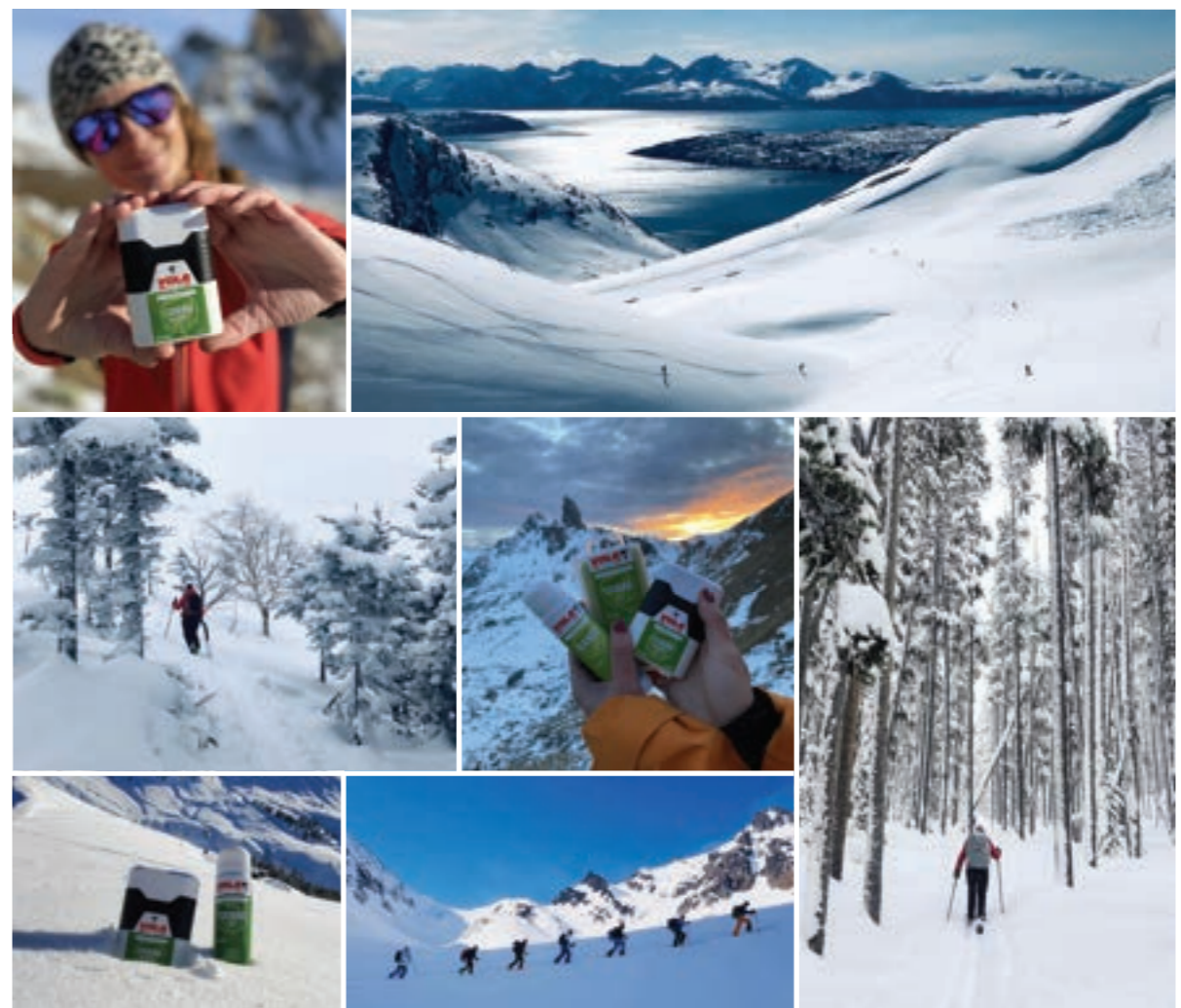

 120°C / 248°F







BASES

 Les Bases Wax sont des farts développés pour les compétiteurs. Grâce à 3 niveaux de dureté, soft/medium/hard, et différentes spécificités (graphite, additivé ou non, etc...) ces farts répondent à tous les besoins: protection ou imprégnation de la semelle, performances sur des neiges chaudes, froides, sèches et/ou anciennes. Cette gamme de farts de pointe, riche et variée, permet de cibler le produit nécessaire suivant la pratique (alpin, nordique, randonnée, saut à ski, courses ou entraînement) pour préparer son matériel de façon optimale.

 Wax Bases are waxes developed for competitors. Thanks to 3 levels of hardness, soft / medium / hard, and different specificities (graphite, etc...) these waxes answer all the needs: protection or impregnation of the ski base, performances on warm, cold, dry snow and / or old snow. This range of advanced waxes makes it possible to target the necessary product according to the practice (alpine, nordic, touring, ski jumping, races or training) to prepare its equipment in an optimal way.

 Die Basis Wax sind Waxe die für Wettkämpfer entwickelt wurden. Dank drei Härtestufen, soft/medium/hart, und verschiedene Besonderheiten (graphite, usw.) decken diese Waxe jede Bedürfnisse: Schutz oder Imprägnierung des Belages sowie Leistungsstärke auf jeder Schneeart. Diese hochwertige und breite Waxreihe erlaubt eine Produktauswahl gemäss der Disziplin (alpin, nordisch, skitouring, skispringen, usw.) um seine Ausrüstung optimal vorzubereiten.

 Le scioline base sono scioline sviluppate per gli atleti. Grazie a 3 livelli di durezza, morbida / media / dura e diverse specificità (grafite, ecc ...) queste scioline rispondono a tutte le esigenze: protezione o impregnazione della suola, prestazioni su neve calda, fredda, asciutta e / o vecchia. Questa gamma di scioline avanzate, ricca e varia, consente di avere il prodotto necessario a seconda la pratica (alpin, nordico, escursione, salto con gli sci, gare o allenamento) per preparare la propria attrezzatura in modo ottimale.

Special Bases



MX 901 Base
250ml REF. 254627
200g REF. 224126
500g REF. 224127

MX 901. Base polyvalente, idéale pour l'entraînement. Spécialement développée pour éviter le blanchiment des semelles. Adaptée également à l'imprégnation des skis neufs avec une housse Thermojoimax.

MX 901. Training ski wax PRO. Developed to avoid the burn of the base which occurs on aggressive man-made snows. MX901 is also made for the impregnation of new skis with a Thermojoimax.

MX 901. Vielseitige Anwendung, ideal fürs Training. Es erlaubt auf aggressivem Schnee zu trainieren, da der Skibelag besser geschützt ist. Auch geeignet für Imprägnierung von neuen Rennskis mit Thermojoimax.

MX 901. Specialmente sviluppato per proteggere le solette dell'abrasione delle neve artificiale aggressive. Fatto per impregnare nuovi sci di competizione con un Thermojoimax.



VRB Base
200g REF. 224101

Base graphitée destinée au géant, super géant et descente. Cette base convient très bien aux neiges très froides et sèches.

For GS, Super G and Downhill on very cold and dry snow.

Graphitwachs für Riesenstalom, Super G und Downhill. Besonders geeignet für kalten und trockenen Schnee. Base con grafite destinata al gigante, super-G e discesa. Ottimale per nevi fredde e asciutte.



Graphite Base
200g REF. 224101

Fart graphité pour l'entretien.

Graphite wax for maintenance.

Graphitwachs für die Wartung.

Cera di grafite per manutenzione.



Graphite Base LM Race
80g REF. 224156 / 200g REF. 224155

Base graphitée, à utiliser comme base antistatique.

Graphite base, to be used as antistatic base.

Graphitierte Basis, als antistatische Unterlage zu benutzen.

Base in grafite, da utilizzare come base antistatica.



Hard Base Liquid
250ml REF. 224630



Hard Base
200g REF. 224130



Medium Base Liquid
250ml REF. 224631



Medium Base
80g REF. 224034 / 200g REF. 224131



Medium Base LM Race
200g REF. 224152



Keramic - Ski Jumping Base
200g REF. 225060

Fart spécial Ceramic pour saut à skis sur tremplins synthétiques.

Special Ceramic wax for Ski Jumping.

Special Ceramic Wachs für Skippringen.

Sciolina speciale Ceramic per il salto a sci.

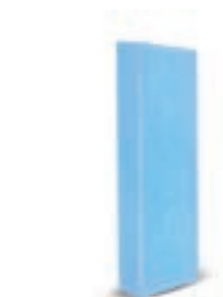

X-Hard Base
200g REF. 224115

Special Extra Hard. Durcisseur.

Special Extra Hard. Hardener.

Special Extra Hard. Härter.

Special Extra Hard. Induritore.



Soft Base
200g REF. 224133



Soft Base LM Race
200g REF. 224154

Hard Base

Protège contre l'abrasion de la neige, limitant l'assèchement de vos semelles. Excellente qualité d'accélération, idéale pour les disciplines techniques.

Protects against abrasion of snow, while limiting the drying out of the ski bases. Excellent acceleration quality, ideal for technical disciplines.

Schützt effektiv vor Schneeschäden. Hervorragende Beschleunigungsqualität, ideal für technische Disziplinen.

Protegge efficacemente contro l'abrasione della neve. Eccellente qualità di accelerazione, ideale per le discipline tecniche.

Medium Base

À utiliser seule ou comme première couche, la Base Medium combine une bonne accélération et agit à des vitesses importantes. Elle est recommandée pour les disciplines GS et SuperG en ski alpin. L'endurance de ce fart est aussi idéale pour les courses longues distances en ski de fond. La version LMach est à utiliser lors des conditions humides.

To use alone or as a first layer, this base mix good acceleration and works on high speeds. Recommended for GS and SuperG disciplines in alpine skiing. Ideal for long distance races in crosscountry skiing. LMach version is made for wet conditions.

Vor dem Auftragen von Race Wax allein oder als erste Schicht zu verwenden. Empfohlen für GS und SuperG im Alpin. Ideal für lange Distanzen im Langlauf. Die LMach Version ist bei nassen Bedingungen zu benutzen.

Da usare da sola o come prima mano prima di applicare cera Race. Consigliato per le discipline GS e SuperG nello sci alpino. Ideale per le gare di lunga distanza nello sci di fondo. LMach adatto per neve umide. LMach adatto per neve umide.

Soft Base

Base tendre permettant d'atteindre des vitesses très élevées. Sa grande adhérence lui permet d'agir longtemps après la phase d'accélération. Cette base est recommandée pour les disciplines de vitesse. La version LMach est à utiliser lors des conditions humides.

Soft wax made to reach high speeds. Its high adhesion to the ski base allows to works longer after acceleration phases. LMach version is made for wet conditions.

Weiches Wax entwickelt als perfekte Basis für hohe Geschwindigkeiten. Durch die extrem guten Haftigenschaften am Belag ist diese Basis ideal für die Speed-Disziplinen. Die LMach Version ist bei nassen Bedingungen zu benutzen.

La base soft e' stata sviluppata per ottenere alta velocità. La sua grande aderenza alla solettagli permette di lavorare bene dopo la fase di accelerazione. LMach adatto per neve umide.



| | | | | |
|-------|----------|----------------|--------|------------|
| 120°C | 115°C | 125°C | 120°C | 145°C |
| VRB | Graphite | LMach Graphite | MX 901 | X-Hard |
| 140°C | 135°C | 125°C | 120°C | 110°C |
| Hard | Medium | LMach Medium | Soft | LMach Soft |



RACING WAX



RACE

FR
Vola a travaillé depuis 2018 sur la recherche de substituants au fluor comparativement aussi performants. Notre objectif a été de limiter au maximum le coefficient de friction entre le ski et la neige. Les cires et paraffines connues et employées par VOLA depuis des décennies ont été associées à un mélange d'additifs apportant un réel gain de performances. Ces nouvelles formulations sont le fruit de nombreuses recherches et études menées en laboratoire et sur le terrain. Des tests sur neige en toutes conditions ont été réalisés dans 5 pays pour permettre la mise au point de ces formulations nouvelles et performantes. La formule élaborée, comprenant, entre autres, des lubrifiants à base céramique, n'est pas seulement un substitut aux anciens farts fluorés, mais une alternative réelle offrant un gain de glisse significatif.

GB
Vola has been working since 2018 on the search for comparatively equally effective fluorine substitutes. Our goal was to limit the coefficient of friction between the ski and the snow as much as possible. The paraffins known and used by VOLA for decades have been associated with a mixture of additives providing a real gain in performance. This new formulation is the result of extensive research and studies carried out in the laboratory and in the field. Tests on snow in all conditions were carried out in 5 countries to allow the development of these new and efficient formulations. The elaborated formula, including among others ceramic-based lubricants, is not only a substitute for old fluorinated waxes, but a real alternative offering a significant gain in glide.

DE
Vola ist seit 2018 auf der Suche nach einem vergleichsweise wirksamen Fluorersatzstoff. Unser Ziel war es den Reibungskoeffizient zwischen Ski und Schnee soweit wie möglich zu begrenzen. Die Paraffine, die VOLA seit Jahrzehnten kennt und verwendet, wurden mit einer Mischung von Additiven in Verbindung gebracht, die einen echten Leistungsgewinn erzielen. Diese neue Formel ist das Ergebnis umfangreicher Forschungen und Studien, die im Labor und vor Ort durchgeführt wurden. In fünf Ländern wurden Schneetests unter allen Bedingungen durchgeführt, um die Entwicklung dieser neuen und effizienten Formel zu ermöglichen. Die erarbeitete Formel, zu der unter anderem Schmiermittel auf Keramikbasis gehören, ist nicht nur ein Ersatz für Fluor-Haltige Wachse, sondern auch eine echte Alternative, die einen erheblichen Gleitgewinn bietet.

IT
Vola lavora dal 2018 alla ricerca di sostituti del fluoro che siano ugualmente efficaci. Il nostro obiettivo è limitare il più possibile il coefficiente di attrito tra lo sci e la neve. Le paraffine conosciute e utilizzate da VOLA da decenni sono state ora associate ad una miscela di additivi che forniscono un reale guadagno di prestazioni. Questa nuova formula è il risultato di approfondite ricerche e studi effettuati sia in laboratorio che sul campo. Per consentire lo sviluppo di queste nuove formule sono stati effettuati test su neve in 5 paesi diversi ed in tutte le condizioni. La formula elaborata, che include tra gli altri lubrificanti a base di ceramica, non è solo un sostituto delle vecchie cere fluorurate, ma una vera alternativa che offre un significativo guadagno di scorrevolezza.

LM_{RACE}

LOW ABRASION **NEW**

Fart de course conçu pour des neiges peu abrasives. Dédiee à des neiges fraîches et tombantes, cette ligne est sans fluor.

Racing wax designed for low-abrasion snow. Dedicated to fresh and falling snows, this line is fluor free.

Rennwachs, das für wenig abrasiven Schnee entwickelt wurde. Diese Linie ist für Neuschnee und Schneefall bestens geeignet und frei von Fluor.

Sciolina da corsa progettata per neve a bassa abrasione. Adatta per neve nuova e fresca. Linea Fluor free.

HM_{RACE}

HIGH ABRASION **NEW**

Fart de course conçu pour des neiges abrasives. Dédiee à des neiges fraîches et tombantes, cette ligne est sans fluor.

Racing wax designed for abrasive snow. Dedicated to fresh and falling snows, this line is fluor free.

Rennskiwachs für hohe Luftfeuchtigkeit. Rennwachs, das für abrasiven Schnee entwickelt wurde. Diese Linie ist für Neuschnee und anhaltenden Schneefall ideal geeignet und frei von Fluor.

Cera da corsa progettata per la neve abrasiva. Adatta per neve nuova e fresca. Linea fluor free.

MOLY

Fart de course dédié aux neiges anciennes, sales et artificielles grâce à l'ajout de molybdène. Composée de lignes LMach et HMach, solides et liquides, cette gamme est sans fluor.

Racing ski wax dedicated to old, dirty and artificial snows thanks to the addition of molybdenum additives. Composed of LMach and HMach lines, solid and liquid, this range is fluor free.

Dank der Zugabe von Molybdänzusätzen gibt es ein Rennskiwachs für künstlichen, schmutzigen und alten Schnee, diese Serie besteht aus L-Mach und H-Mach, in fester und flüssiger Form und ist frei von Fluor.

Sciolina racing dedicata a neve artificiale vecchia (trasformata) e sporca, grazie all'aggiunta di Molybdeno. Composta con Lmach e Hmach, solida e liquida, fa parte del range fluor free.

ACTIVE GLIDE ADDITIVE

- Formules créées en laboratoire
Formulas created in laboratory
- Farts testés dans 5 pays aux qualités de neiges différentes
Waxes tested in 5 countries with different snow qualities
- Tests vérifiés en intérieur (dômes) et extérieur (pistes, glaciers)
Tests verified indoors (ski hall) and outdoors (slopes, glaciers)
- Certifié sans fluor
Certified fluoride free
- Molécules actives de glisse approuvées
Approved sliding active molecules

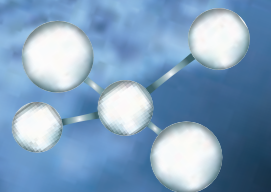



AIR T° -25°C > -10°C / -13°F > 14°F



RACE



LMrace Blue
80g / 2.8 oz Ref 280111
80g / 2.8 oz x 13 pcs Ref 280111K
200g / 7 oz Ref 280211

LMrace Blue
60 ml / 2 fl oz Ref 280511
100 ml / 3.4 fl oz Ref 280611
250 ml / 8.4 fl oz Ref 280711

LM RACE

LOW ABRASION

Fart de course conçu pour des neiges peu abrasives. Dédiée à des neiges fraîches et tombantes, cette ligne est sans fluor.

Racing wax designed for low-abrasion snow. Dedicated to fresh and falling snows, this line is fluor free.

150°C / 302°F



HMrace Blue
40g / 1.4 oz Ref 280021
40g / 1.4 oz x 22 pcs Ref 280021K
80g / 2.8 oz Ref 280121
80g / 2.8 oz x 13 pcs Ref 280121K
200g / 7 oz Ref 280221

HMrace Blue
60 ml / 2 fl oz Ref 280521
100 ml / 3.4 fl oz Ref 280621
250 ml / 8.4 fl oz Ref 280721

HM RACE

HIGH ABRASION

Fart de course conçu pour des neiges abrasives. Dédiée à des neiges fraîches et tombantes, cette ligne est sans fluor.

Racing wax designed for abrasive snow. Dedicated to fresh and falling snows, this line is fluor free.

160°C / 320°F



LMrace Blue Moly
80g / 2.8 oz
Ref 280131

HMrace Blue Moly
80g / 2.8 oz
Ref 280141

LMrace Blue Moly
100 ml / 3.4 fl oz
Ref 280631

HMrace Blue Moly
100 ml / 3.4 fl oz
Ref 280641

MOLY

Fart de course dédié aux neiges anciennes, sales et artificielles grâce à l'ajout de molybdène. Composée de lignes LMach et HMach, solides et liquides, cette gamme est sans fluor.

Racing ski wax dedicated to old, dirty and artificial snows thanks to the addition of molybdenum additives. Composed of LMach and HMach lines, solid and liquid, this range is fluor free.

150°C / 302°F



AIR -12°C > -4°C / 10°F > 25°F



RACE



LMrace Purple
80g / 2.8oz Ref 280112
80g / 2.8oz x 13pcs Ref 280112K
200g / 7oz Ref 280212

LMrace Purple
60ml / 2 fl oz Ref 280512
100ml / 3.4 fl oz Ref 280612
250ml / 8.4 fl oz Ref 280712

LM RACE

LOW ABRASION

Fart de course conçu pour des neiges peu abrasives. Dédiée à des neiges fraîches et tombantes, cette ligne est sans fluor.

Racing wax designed for low-abrasion snow. Dedicated to fresh and falling snows, this line is fluor free.

🔥 140°C / 284°F



HMrace Purple
40g / 1.4oz Ref 280022
40g / 1.4oz x 22pcs Ref 280022K
80g / 2.8oz Ref 280122
80g / 2.8oz x 13pcs Ref 280122K
200g / 7oz Ref 280222

HMrace Purple
60ml / 2 fl oz Ref 280522
100ml / 3.4 fl oz Ref 280622
250ml / 8.4 fl oz Ref 280722

HM RACE

HIGH ABRASION

Fart de course conçu pour des neiges abrasives. Dédiée à des neiges fraîches et tombantes, cette ligne est sans fluor.

Racing wax designed for abrasive snow. Dedicated to fresh and falling snows, this line is fluor free.

🔥 150°C / 302°F



LMrace Purple Moly
80g / 2.8oz
Ref 280132

HMrace Purple Moly
80g / 2.8oz
Ref 280142

LMrace Purple Moly
100ml / 3.4 fl oz
Ref 280632

HMrace Purple Moly
100ml / 3.4 fl oz
Ref 280642

MOLY

Fart de course dédié aux neiges anciennes, sales et artificielles grâce à l'ajout de molybdène. Composée de lignes LMach et HMach, solides et liquides, cette gamme est sans fluor.

Racing ski wax dedicated to old, dirty and artificial snows thanks to the addition of molybdenum additives. Composed of LMach and HMach lines, solid and liquid, this range is fluor free.

🔥 140°C / 284°F





AIR $-5^{\circ}\text{C} > 0^{\circ}\text{C} / 23^{\circ}\text{F} > 32^{\circ}\text{F}$



RACE



LMrace Red
80g / 2.8oz Ref 280113
80g / 2.8oz x 13pcs Ref 280113K
200g / 7oz Ref 280213

LMrace Red
60ml / 2 fl oz Ref 280513
100ml / 3.4 fl oz Ref 280613
250ml / 8.4 fl oz Ref 280713

LM RACE

LOW ABRASION

Fart de course conçu pour des neiges peu abrasives. Dédiée à des neiges fraîches et tombantes, cette ligne est sans fluor.

Racing wax designed for low-abrasion snow. Dedicated to fresh and falling snows, this line is fluor free.

140°C / 284°F



HMrace Red
40g / 1.4oz Ref 280023
40g / 1.4oz x 22pcs Ref 280023K
80g / 2.8oz Ref 280123
80g / 2.8oz x 13pcs Ref 280123K
200g / 7oz Ref 280223

HMrace Red
60ml / 2 fl oz Ref 280523
100ml / 3.4 fl oz Ref 280623
250ml / 8.4 fl oz Ref 280723

HM RACE

HIGH ABRASION

Fart de course conçu pour des neiges abrasives. Dédiée à des neiges fraîches et tombantes, cette ligne est sans fluor.

Racing wax designed for abrasive snow. Dedicated to fresh and falling snows, this line is fluor free.

140°C / 284 °F



LMrace Red Moly
80g / 2.8oz
Ref 280133

HMrace Red Moly
80g / 2.8oz
Ref 280143

LMrace Red Moly
100ml / 3.4 fl oz
Ref 280633

HMrace Red Moly
100ml / 3.4 fl oz
Ref 280643

MOLY

Fart de course dédié aux neiges anciennes, sales et artificielles grâce à l'ajout de molybdène. Composée de lignes LMach et HMach, solides et liquides, cette gamme est sans fluor.

Racing ski wax dedicated to old, dirty and artificial snows thanks to the addition of molybdenum additives. Composed of LMach and HMach lines, solid and liquid, this range is fluor free.

130°C / 266°F





AIR $-2^{\circ}\text{C} > 10^{\circ}\text{C} / 28^{\circ}\text{F} > 50^{\circ}\text{F}$



RACE



LMrace Yellow
80g / 2.8 oz Ref 280114
80g / 2.8 oz x 13 pcs Ref 280114K
200g / 7 oz Ref 280214

LMrace Yellow
60 ml / 2 fl oz Ref 280514
100 ml / 3.4 fl oz Ref 280614
250 ml / 8.4 fl oz Ref 280714

LM RACE

LOW ABRASION

Fart de course conçu pour des neiges peu abrasives. Dédiee à des neiges fraîches et tombantes, cette ligne est sans fluor.

Racing wax designed for low-abrasion snow. Dedicated to fresh and falling snows, this line is fluor free.

$130^{\circ}\text{C} / 266^{\circ}\text{F}$



HMrace Yellow
40g / 1.4 oz Ref 280024
40g / 1.4 oz x 22 pcs Ref 280024K
80g / 2.8 oz Ref 280124
80g / 2.8 oz x 13 pcs Ref 280124K
200g / 7 oz Ref 280224

HMrace Yellow
60 ml / 2 fl oz Ref 280524
100 ml / 3.4 fl oz Ref 280624
250 ml / 8.4 fl oz Ref 280724

HM RACE

HIGH ABRASION

Fart de course conçu pour des neiges abrasives. Dédiee à des neiges fraîches et tombantes, cette ligne est sans fluor.

Racing wax designed for abrasive snow. Dedicated to fresh and falling snows, this line is fluor free.

$160^{\circ}\text{C} / 320^{\circ}\text{F}$



LMrace Yellow Moly
80g / 2.8 oz
 Ref 280134

HMrace Yellow Moly
80g / 2.8 oz
 Ref 280144

LMrace Yellow Moly
100 ml / 3.4 fl oz
 Ref 280634

HMrace Yellow Moly
100 ml / 3.4 fl oz
 Ref 280644

MOLY

Fart de course dédié aux neiges anciennes, sales et artificielles grâce à l'ajout de molybdène. Composée de lignes LMach et HMach, solides et liquides, cette gamme est sans fluor.

Racing ski wax dedicated to old, dirty and artificial snows thanks to the addition of molybdenum additives. Composed of LMach and HMach lines, solid and liquid, this range is fluor free.

$125^{\circ}\text{C} / 257^{\circ}\text{F}$





No Fluor
APPROVED



TOP FINISH

RACE

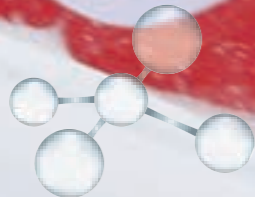

× 44 ×

RACE PROPULSOR

-  Bleu, pour les neiges froides = -12°C > -5°C / 10°F > 23°F
Jaune, pour les neiges chaudes = -5°C > 0°C / 23°F > 32°F
Version Moly pour les neiges vieilles, sales et artificielles.
À crayonner légèrement puis polir avec un liège ou une feutrine.
Enfin brosser avec une brosse crin de cheval.
-  Blue, for cold snow = -12°C > -5°C / 10°F > 23°F
Yellow, for warm snow = -5°C > 0°C / 23°F > 32°F
Moly version for old, dirty and artificial snow.
Rub on slightly and then polish with a pad or a cork.
Then brush out with a horsehair brush.
-  Blau, für kalten Schnee = -12°C > -5°C / 10°F > 23°F
Gelb, für warmen Schnee = -5°C > 0°C / 23°F > 32°F
Race Wachse mit Molybdän-Anteil für alten- Schnee.
Moly Version für Kunstschnee und schmutzigen, Altschnee. Leicht aufreiben, dann mit einem Kork oder einem Wollfilz einpolieren.
Schließlich mit einer Rosshaar Bürste ausbürsten.
-  Blu, per nevi fredde = -12°C > -5°C / 10°F > 23°F
Giallo, per nevi calde = -5°C > 0°C / 23°F > 32°F
Contiene un additivo al molibdeno per la neve vecchia e artificiale.
Sfregare leggermente e lucidare con un feltro o un sughero. Infine spazzolare con una spazzola in crine di cavallo.







Ref 280000 Race Propulsor Blue
Ref 280012 Race Propulsor Blue Moly



Ref 280001 Race Propulsor Yellow
Ref 280013 Race Propulsor Yellow Moly

RACE ACCELERATOR

-  Le M23 est un produit hautement additivé faisant parti de la gamme Race. Utilisé comme Top Finish, il vous apportera une accélération optimale. Sans fluor, le M23 est conditionné en aérosol, sous 4 plages de températures (bleu, violet, rouge jaune) et livré avec brosse mixte feutrine/nylon.
-  The M23 is a highly additivated product from the Race range. Used as a Top Finish, it will bring you an optimal acceleration. Without fluorine, the M23 is packaged in aerosol, under 4 temperature ranges (blue, purple, red, yellow) and delivered with a mixed felt/nylon brush.
-  M23 ist ein hochadditiviertes Produkt aus der Race-Reihe. Als Top Finish sorgt es für eine optimale Beschleunigung. M23 ist fluorfrei und wird in Spraydosen in vier Temperaturbereichen (blau, violett, rot, gelb) und mit einer Bürste aus Filz und Nylon geliefert.
-  M23 è un prodotto altamente additivato della gamma Race. Utilizzato come Top Finish, garantisce un'accelerazione ottimale. Privo di fluoro, M23 è confezionato in bombola aerosol, in 4 gamme di temperatura (blu, viola, rosso, giallo) e fornito con un pennello misto feltro/nylon.



Blue 280901 Purple 280902 Red 280903 Yellow 280904



HCM
10 ml / 0.3 oz
Ref 280705

NEW

Huile universelle à appliquer sur les chants des skis de vitesse. Ne pas appliquer sur la semelle.
Universal Sidewall oil for speed events. This oil should only be used on the sidewall, do not apply it on the base.

45 ×

WAX

MACH

NORDIC CLASSIC WAX

KLISTER WAX / KICK WAX

GRIP WAX

| | Fresh Snow | Old Snow | Frozen Snow | Wet Snow |
|--------------|------------|----------|-------------|----------|
| All T° | P44 GRIP | | | |
| Very cold | P43 GRIP | | K43 | |
| Cold | P40 GRIP | P45 GRIP | K40 | K40 |
| Moderate | P41 GRIP | P46 GRIP | K41 | K41 |
| Intermediate | P42 GRIP | | | K42 |

K40 REF. 225300

Klister Bleu pour neiges glacées et températures de neige froides de -14°C à -5°C.
Blue klister for icy snow and cold snow temperatures from -14°C to -5°C.
BlueKlister für eisigen Schnee im angegebenen Schneetemperaturbereich : -14°C / -5°C
Sciolina di tenuta in pasta per nevi trasformate e mista artificiali a cristallo grosso. Neve temperatura : -14°C / -5°C

K41 REF. 225301

Klister Violet pour neiges transformées et humides. Températures de neige allant de -6°C à -3°C.
Violet klister for humide snow and snow temperatures from -6°C to -3°C.
VioletKlister für eisigen Schnee or feuchtem Schnee im angegebenen Schneetemperaturbereich : -6°C / -3°C.
Sciolina di tenuta in pasta per nevi trasformate e mista artificiali a cristallo grosso. Neve temperatura : -6°C / -3°C;

K42 REF. 225302

Klister Rouge pour neiges transformées, très humides autour du point de congélation. Haute qualité de glisse. Températures de neige de -3°C à 0°C.
Red klister for very humide snow, close to the frozen point and snow temperatures from -3°C to 0°C.
RedKlister für feuchtem Schnee im angegebenen Schneetemperaturbereich : -3°C / 0°C
Sciolina di tenuta in pasta per nevi trasformate e mista artificiali a cristallo grosso o bagnato. Neve temperatura : -3°C / 0°C.

K43 REF. 225303

Klister Vert pour neiges glacées et températures de neige très froides de -20°C à -10°C. Peut être utilisé en base pour améliorer la tenue des autres klister.
Green klister for icy snow and extremely cold snow temperatures from -20°C to -10°C. Could be used as a base to improve the durability of other klister.
GreenKlister für eisigen Schnee im angegebenen Schneetemperaturbereich : -20°C / -10°C. Auch utillisiert als Grundlage für die anderen Klister.
Sciolina di tenuta in pasta per nevi caldi e mista artificiali a cristallo grosso. Neve : -20°C / -10°C. È possibile di utillisiere come una base.

K44 REF. 225304

Klister Argent pour neiges transformées autour du point de congélation. Température de neige : de -1°C à 0°C.
Silver klister for transformed snow around the frozen point. Snow temperatures : from 0°C to +5°C.
SilverKlister für eisigen Schnee im angegebenen Schneetemperaturbereich : -1°C / 0°C.
Sciolina di tenuta in pasta per nevi trasformate e mista artificiali a cristallo bagnato. Neve temperatura : -1°C / 0°C.

Skin glide REF. 225306

Fart liquide universel destiné aux peaux pour la pratique du ski de fond classique. Évite le risque de givrage et de bottage. Améliore la glisse et l'accroche grâce à ses propriétés imperméabilisantes.
Universal liquid wax for classic cross-country skins. Prevents the risk of icing and kicking. Improves glide and grip thanks to its waterproofing properties.
Universelles flüssiges Wachs für Felle beim klassischen Skilanglauf. Verhindert das Risiko von Vereisung und Stiefelbildung. Verbessert die Gleitfähigkeit und den Grip dank seiner wasserabweisenden Eigenschaften.
Cera liquida universale per le pelli classiche da sci di fondo. Previene il rischio di formazione di ghiaccio e di calci. Migliora la scorrevolezza e l'aderenza grazie alle sue proprietà impermeabilizzanti.



P43 REF. 225403
-20°C / -10°C

45g. Fart de retenue pour neiges fraîches et tombantes et températures de neige très froides. Peut être utilisé en base pour améliorer la tenue des autres poussettes.
45g. Grip wax for fresh or falling snow and very cold snow. Could be used as a base to improve the durability of other sticks.
45g. GripWax für kalte Verhältnisse und Neuschnee. Kann auch als Basis für die Verbesserung des Haltes von anderen Grip Waxe genutzt werden.
45g. Sciolina di tenuta per nevi cadenti, nevi fresca e miste artificiali a cristallo fine o poco trasformate. È possibile di utillisiere il stick Green come una base.



P40 REF. 225400
-11°C / -5°C

45g. Poussette Bleu. Fart de retenue pour neiges fraîches ou tombantes et températures froides.
45g. Blue stick. Grip wax for fresh or falling snow and cold snow temperature.
45g. Blau Gripwachs. Bei kalten Verhältnissen. Für Neuschnee.
45g. Sciolina di tenuta per nevi cadenti, nevi fresca e miste artificiali a cristallo fine o poco trasformate.



P45 REF. 225405
-11°C / -5°C

45g. Poussette Bleu Extra. Similaire à la P40 mais meilleure sur les neiges vieilles.
45g. Blue stick Extra. Same as the P40 but more efficient on old snows.
45g. Blue Gripwachs Extra. Gleich wie der P40 aber effizienter auf alten Schnee.
45g. Uguale al P40, ma più efficace su neve vecchia.



P41 REF. 225401
-5°C / -1°C

45g. Poussette Violet. Fart de retenue pour neiges fraîches ou tombantes.
45g. Violet stick. Grip wax for fresh or falling snow and intermediate snow temperature.
45g. Violett Gripwachs. Bei trockenem Schneefall und feinkörnigem, neuem Schnee.
45g. Sciolina di tenuta per nevi cadenti, nevi fresca e miste artificiali a cristallo fine o poco trasformate.



P46 REF. 225406
-5°C / -1°C

45g. Poussette Violet Extra. Similaire à la P41 mais meilleure sur les neiges vieilles.
45g. Violet stick Extra. Same as the P41 but more efficient on old snows.
45g. Violet Gripwachs. Gleich wie der P41 aber effizienter auf alten Schnee.
45g. Uguale al P41, ma più efficace su neve vecchia.



P42 REF. 225402
-2°C / 0°C

45g. Poussette Rouge. Fart de retenue pour neiges fraîches ou tombantes et températures de neige proches du point de congélation.
45g. Red stick. Grip wax for use in fresh or falling snow, on icy tracks and high snow temperature.
45g. Red Gripwachs. Bei feuchtem Neuschnee, Schneefall, bei nicht glasig werdender Spur.
45g. Sciolina di tenuta per nevi cadenti, nevi fresca e miste artificiali a cristallo fine o poco trasformate.



P44 REF. 225404

45g. Poussette Universel. Fart universel de retenue pour neiges fraîches ou tombantes.
45g. All-round stick. Grip wax for fresh or falling snow. Ideal for beginners, easy and quick to use.
45g. Allround Gripwachs für Neuschnee und Schneefall. Sehr gut für den Einsteiger, einfach in der Anwendung.
45g. Sciolina universale di tenuta per nevi cadenti, nevi fresca e miste artificiali a cristallo fine o poco trasformate. Molto facile da utillisiere per tutti i tipi di sciatore che cercano una sciolina di tenuta polyvalente per tutti i tipi di neve.

PACK OF 3 KICK WAX
P41 + P42 + P44
REF. 225410

PACK OF 2 KICK WAX + 1 CORK
P41 + P42
REF. 225411



Alpine & Nordic

SKI WAX remover

• DÉFARTEUR •



R021

REF. 229100 **200g**
100 °C / 212 °F

Paraffine à défarter R021. 200 g. Fert très tendre composé uniquement de paraffines à coefficient de fusion très faible lui procurant une fluidité exceptionnelle. Utilisé lors du raclage à chaud, le R021 permet de nettoyer la semelle en profondeur et de dilater les pores de la semelle afin d'augmenter la rétention des farts de glisse. Peut être utilisé avant chaque fartage.

Parafin R021. Very soft wax composed entirely of paraffins with melting very low coefficient, giving it exceptional fluidity. Used when hot-scraping, R021 cleans the base depth and open the pores of the base to increase the retention of gliders. Can be used before each waxing.

Parafin R021. Sehr weiches Wax ausschliesslich aus Parafin bestehend, mit niedrigem Schmelzpunkt, was eine ungleiche Fließfähigkeit beschafft. Beim heiss-Abkratzen zu benutzen. Der R021 erlaubt es den Belag in tiefe zu reinigen und dessen Poren zu öffnen um die Retention der Gleitwaxe zu erhöhen. Kann vor jedem Waxen verwendet werden.

Paraffina di pulizia. R021. Sciolina molto morbido composto interamente di paraffine con fusione bassissimo coefficiente dando fluidità eccezionale. Utilizzato quando raschiando caldo, R021 pulisce la suola di profondità e aprire i pori della suola per aumentare la ritenzione di alianti. Può essere usato prima di ogni ceretta.



Pure

REF. 239601 **250 ml**
REF. 239700 **1L**
REF. 239701 **5L**

Solvants de dégraissage permettant de dissoudre le fart et de nettoyer les saletés et impuretés.

Sans pictogramme de danger :

Plus respectueux de la santé et de l'environnement.

Degreasing solvents for dissolving wax and cleaning dirt and impurities.

No danger pictograms :

More respectful of health and the environment.

Entfettungslösungsmittel zum Auflösen von Wachs und zum Entfernen von Schmutz und Unreinheiten.

Solventi sgrassanti per sciogliere la cera e pulire lo sporco e le impurità.



© Agence Zoom



Standard

REF. 229611 **125 ml aerosol**
REF. 229601 **250 ml**
REF. 229700 **1L**
REF. 229701 **5L**

Défarteur liquide.
Liquide wax remover.
Flüssigwachsreiniger.
De-sciolinatore liquido.



Pro

REF. 229603 **250 ml**
REF. 229702 **1L**

Défarteur liquide.
Liquide wax remover.
Flüssigwachsreiniger.
De-sciolinatore liquido.



Glide Cleaner

REF. 229602 **250 ml**
REF. 229703 **1L**

Pour une remise à zéro des skis après un fartage avec du fart fluoré.
For cleaning the ski base after waxing with fluorinated wax.
Zur Reinigung des Belages nach dem Waxen mit fluorierten Waxe.
Per la pulizia della soletta dopo la ceretta con cera fluorurati.



ACCESSORIES



× 50 ×

× 51 ×

AFFÛTAGE × SHARPENING × KANTENSCHLEIFZUBEHÖR × AFFILATURA



Base Edge

Base Edge pour tomber les carres côté semelle.
 Base edge for a precise level on the base edge.
 Base Edge, verstellbar für das belagseitige Einschleifen.
 Base Edge.
 REF. 011118 - BASE EDGE 0.5°
 REF. 011119 - BASE EDGE 0.75°
 REF. 011120 - BASE EDGE 1°



Adjustable Base Edge REF. 011027

Base Edge pour tomber les carres. Réglable de 0,5° à 1,5°.
 Base edge for a precise level on the base edge. Adjustable from 0,5° to 1,5°.
 Base Edge, verstellbar für das belagseitige Einschleifen 0,5° bis 1,5°.
 Base Edge regolabile. Da 0,5° a 1,5°.



Racing Guide

Equerre Racing. REF. 011021 - 88°
 Racing file guide. REF. 011022 - 87°
 Racing Kantenwinkel.
 Squadretta Racing.



WC Guide

Equerre WC. REF. 011015 - 90°
 WC guide. REF. 011016 - 89°
 WC Kantenwinkel. REF. 011017 - 88°
 Squadretta WC. REF. 011018 - 87°
 REF. 011019 - 86°
 REF. 011020 - 85°



Edgerazor REF. 011132

Outil pour chant à lame ronde permettant de nombreux réglages. Simple et économique.
 Sidewall tool with a round blade allowing different adjustments. Cheap and easy to use.
 Seitenwangenabzieher mit rundem Messer und verschiedenen Einstellmöglichkeiten. Leicht zu benutzen.
 Utensile per lo spigolo a lama rotonda che consente numerose regolazioni. Semplice ed economico.



Pro Sidewall Tool REF. 011051

Outil pour chant PRO. Livré avec une lame ronde pour chants inclinés et une lame carrée pour chants droits.
 Pro Sidewall tool. Delivered with one round blade for inclined edges and one square blade for straight edges.
 Seitenwangenabzieher. Lieferung mit einem Rundmesser für schrägen Kanten und einem Quadrat Messer für gerade Kanten.
 Utensile per lo spigolo PRO. Consegnato con una lama rotonda per gli spigoli inclinati e una lama quadra per spigoli dritti.



Sidewall Carrot Pro REF. 011136

Outil pour chant électrique, compact et ergonomique. Livré avec la lame Medium (GS/SL).
 Electric Sidewall tool, compact and ergonomic. Supplied with medium blade (GS/SL).
 Elektronisches Seitenwangenfräsgerät, ergonomisch und kompakt. Ausgestattet mit einer mittleren Klinge (GS/SL).
 Utensile per la lamina elettrico. In dotazione viene fornito con una mola media (GS/SL)

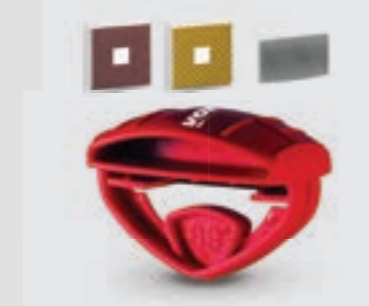

Quick Sharp Basic REF. 011004

Affûteur de poche + Lime
 Pocket sharpener + File
 Kantenwinkel + Feile
 Affilatore tascabile + Lima



Race Sharp REF. 011133

Affûteur de 89° à 86° + mise à plat du ski 0,5° et 1°.
 Sharpener from 89° to 86° + base edge from 0,5° to 1°.
 Kantenwinkel von 89° bis 86° + Base edge 0,5° und 1°.
 Affilatore da 89° a 86° + Base edge da 0,5° e 1°.



1 Ergoss Sharp REF. 011130 2 Ergoss Racing REF. 011131

Affûteur réglable de 90° à 85°.
 Sharpener from 90° to 85°.
 Kantenwinkel Schleifgradeinstellung 90°- 85°.
 Affilatore regolabile 90°- 85°.

Quick Sharp Extra REF. 011005

Affûteur de poche + Lime + Diamant + Abrasive
 Pocket sharpener + File + Diamond + Abrasive
 Kantenwinkel + Feile + Diamantfeile + Abrasive
 Affilatore tascabile + Lima + Pietre diamantate + Abrasive

Race Sharp Kit REF. 011205 **NEW**

VOLA RAZOR EDGE **NEW** TUNING MACHINE REF. 011135

Machine à affûter compacte. Permettant un réglage d'angle de 90° à 86°. Livrée dans sa mallette, avec une pierre coarse et une pierre medium.
 Compact electric tuning machine. Angle adjustment from 90° to 86°. Delivered in its travelling box, with a coarse stone a medium stone.
 Kompakte elektronische Kantenschleifmaschine. Mögliche Winklereinstellung von 90° bis 86°. Wird im Set mit einem Tragekoffer und einem groben sowie einem Medium Stein geliefert.
 Affilalamine elettrico compatto. Regolazione angolo da 90 a 86. Fornito in un box da viaggio con 2 diverse pietre.

REF. 011140 COARSE STONE
 REF. 011141 MEDIUM STONE
 REF. 011142 FIN STONE
 REF. 011143 EXTRA FINE STONE



Carrot Machine REF. 011108

Machine à affûter à pierre Carrot pour skis alpins et snowboard. Livré avec une équerre 87° et 88° et une meule 120. Permet d'affûter le côté chant du ski.
 Electric rotative stone side edge sharpener for ski & snowboard tuning. Delivered with 87° and 88° guides and a stone 120. Allow to tune the edge side.
 Elektrisch rotierender Stein in Schräglage, zum Schärfen der Kanten von Alpinskiern und Snowboards. Geliefert mit einem 87° & einem 88° Winkel, dem 120er Allroundstein, Netzadapter und Schleifgerät.
 Macchina affilalamine per sci e snowboard. Fornita con squadretta 87 e 88° e mola diamantata di grana 120.

240V / 480W / 50Hz



REF. 011124 STONE 80
 REF. 011109 STONE 120
 REF. 011125 STONE 240
 REF. 011126 STONE 320
 REF. 011127 STONE 500
 REF. 011110 STONE CERAMIQUE
 REF. 011111 STONE DIAMOND



REF. 011112 CORNER 89
 REF. 011113 CORNER 88
 REF. 011114 CORNER 87
 REF. 011115 CORNER 86



Accessories

1 REF. 011033
 Pince de fixation.
 File clamp.
 Halteklammer.
 Pinza di fissaggio.
 2 REF. 011047
 Carde à lime.
 File card.
 Feilenbürste mit Messingborsten.
 Spazzola per lima.

AFFÛTAGE × SHARPENING × KANTENSCHLEIFZUBEHÖR × AFFILATURA

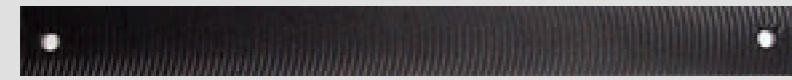

REF. 011034
Lime 300 mm.
300 mm File.
Karosseriefeile 300 mm.
Lima 300 mm.



REF. 011035
Lime double taille 150 mm.
150 mm Double cut File.
150 mm Maxifeile.
Lima doppio taglio.

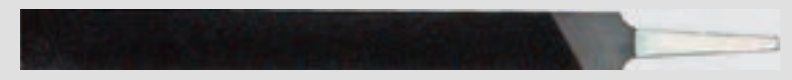

REF. 011038
Lime 200 mm Cut 1.
200 mm File Cut 1.
200 mm Feile Cut 1.
Lima 200 mm Cut 1.



REF. 011036
Lime 150 mm Cut 2.
150 mm File Cut 2.
150 mm Feile Cut 2.
Lima 150 mm Cut 2.

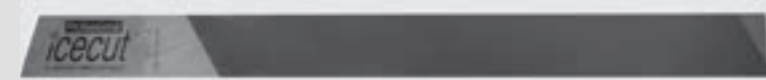

REF. 011039
Lime 200 mm Second cut.
200 mm File Second cut.
200 mm Feile Second cut.
Lima 200 mm Second cut.



REF. 011037
Lime 150 mm Cut «Smooth».
150 mm File Cut «Smooth».
150 mm Feile Cut «Smooth».
Lima 150 mm Cut «Smooth».

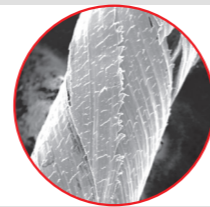

NEW
REF. 011173 - CUT2 EXTRA FINE
REF. 011174 - CUT2 SUPER FINE CUTOFINO
Lime. File. Feile. Lima
100 x 25 mm

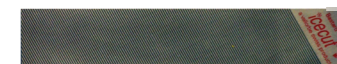

REF. 011032
Lime demi-douce de rechange.
Spare half cut file.
Erzatzfeile.
Lima semi-dolce di ricambio.



REF. 011058 - FINE
REF. 011059 - MEDIUM
Lime Racing.
Racing File.
Racing Feile.
Lima Racing.

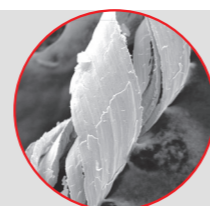

FINITION × FINISHING × FEINTUNING × FINITURA



NEW
VOLA Diamond Plate Basic
REF. 011208 COARSE
REF. 011209 MEDIUM
REF. 011210 FINE

VOLA Plaqueette diamantée petit modèle.
VOLA Small Diamond plate.
VOLA Diamantfeile mit Plakette
VOLA Pietre diamantate piccola.



VOLA Diamond Plate
REF. 011043 COARSE (200)
REF. 011044 STANDARD (400)
REF. 011045 FINE (600)
REF. 011046 VERY FINE (1000)

VOLA Plaqueette diamantée.
VOLA Diamond plate.
VOLA Diamantfeile mit Plakette
VOLA Pietre diamantate.



Diamond Plate ICECUT
REF. 011075 COARSE (200)
REF. 011076 STANDARD (400)
REF. 011077 FINE (600)
REF. 011078 VERY FINE (1000)

Plaqueette diamantée Icecut.
Icecut Diamond plate.
Icecut Diamantfeile mit Plakette.
Pietre diamantate Icecut.



Arkansas Plate
REF. 011049 ARKANSAS HARD
REF. 011050 ARKANSAS EXTRA HARD

Pierre Arkansas dure et très dure. Finition standard et finition course.
Arkansas Hard and Extra Hard stone. For finishing and racing service.
Arkansas Naturalstein, hart und sehr hart.
Pietra Arkansas dura e molto dura. Finitura standard e finitura gara.



Small Diamond Plate
REF. 011040 BLACK
REF. 011041 BLUE
REF. 011042 RED

Lime diamant petit modèle.
Small diamond stone.
Kleine Diamantfeile.
Lima diamantata piccola.



Basic Plate
REF. 011048
Pierre plate. Pierre basique.
Basic oxyde alu stone.
Alu-Oxyd-Stein, Universal.
Pietra piana. Pietra base.

Abrasive Block
REF. 011002
Gomme extra dure. Pour les clubs et l'atelier.
Extra hard rubber abrasive block. For clubs and the workshop.
Kantenbrechgummi hart, für Skiclubs.
Gomma molto dura. Per i club e i negozi.

MINI Blade
Pierre 600 REF. 011165
Céramique REF. 011175

Outil permettant de raviver les carres, de remettre du grip. En ne travaillant que sur la pointe de la carre, il s'adapte à tous types d'affûtages et à tous les angles.
Tool allowing to revive the edges, to restore the grip. By working only on the tip of the edge, it adapts to any type of sharpening and to all angles.
Werkzeug, mit dem die Kanten wiederbelebt werden können, um den Griff wiederherzustellen. Indem nur an der Spitze der Kante gearbeitet wird, passt es sich jeder Art von Schärfung und allen Winkeln an.
Strumento che permette di ravvivare le lamine per ripristinare l'affilatura. Lavorando solo sulla punta del filo si adatta a qualsiasi tipo di affilatura ed a tutti gli angoli.

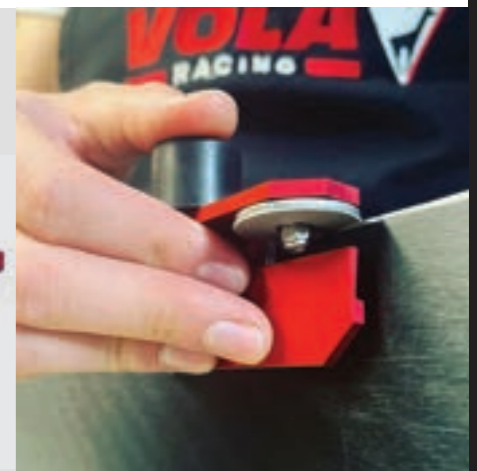

FINITION × FINISHING × FEINTUNING × FINITURA



Plastic Scraper

REF. 012081 / 4MM
REF. 012082 / 3MM
REF. 012083 / 3MM CRYSTAL
REF. 012084 / SNOWBOARD 6MM
REF. 012024 / NORDIC

Racle plastique.
Plastic scraper.
Wachsabziehklinge aus Plexiglas.
Spatola.



3mm + 4mm

Pro Sharpener REF. 011003

Affûte-racles PRO.
PRO scraper sharpener.
PRO Schleifen Schärfen.
Arrotino per spatole PRO.



Metal Scraper REF. 012003

Racle métallique pour la mise à plat et lors de la réparation avec une bougie.

Metal Scraper for base repair and planification.
Metallabziehklinge.
Spatola in metallo per spianare la soletta e per riparazioni.



3mm + 4mm + 5mm

Basic Sharpener REF. 011079

Affûte-racles basique.
Basic scraper sharpener.
Basic Schleifen Schärfen.
Arrotino per spatole basico.



Metallic Planificator REF. 012005

Planimètre et racle métallique. Permet de vérifier si le ski est à plat.

Metallic Planificator. Used to control the flatness.
Haarlineal Alpin, für die Ebenheitskontrolle des Belags.
Utensile con spatola metallica. Per controllare la planarità della soletta.



Electric Sharpener REF. 011134

Affûte-racles électrique, pour racle de 3 à 6mm.
Electrical scraper sharpener, for scrapers from 3 to 6mm.
Elektro Schleifen Schärfen, für Raket von 3 bis 6 mm.
Arrotino per spatole elettrico, per raschietto da 3 a 6 mm.

BROSSAGE × BRUSHING × WACHSBÜRSTE × SPAZZOLATURA



NEW

Performance Red

1 REF. 012085 - RECTANGLE
2 REF. 012100 - OVAL
3 REF. 012101 - ROTO (VOLA - 140MM)

Brosse nylon à poils courts et rigides pour un lustrage des farts durs de la gamme Mach et Racing. A utiliser après la brosse bronze, les poils courts de cette brosse restent perpendiculaires et permettent une action efficace jusqu'au fond de la structure.
Nylon brush with short and stiff bristles for polishing hard waxes of the Mach and Racing range. To be used after the bronze brush, the short bristles of this brush remain perpendicular and allow an effective action to the bottom of the structure.

Nylonbürste mit kurzen, steifen Borsten zum Polieren von Hartwachsen aus der Mach- und Racing-Reihe. Wird nach der Bronzebürste verwendet. Die kurzen Borsten dieser Bürste bleiben rechtwinklig und ermöglichen eine effektive Wirkung bis in die Tiefe der Struktur.

Spazzola di nylon con setole corte e rigide per lucidare le cere dure della gamma Mach e Racing. Da utilizzare dopo la spazzola di bronzo, le setole corte di questa spazzola rimangono perpendicolari e permettono un'azione efficace sul fondo della struttura.



Fine Steel REF. 012033

À utiliser avant le fartage pour nettoyer la semelle en profondeur et tout de suite après le raclage. Indispensable pour les farts liquides.

To be used after the tuning to clean deeply the base and after the waxing in first position. Very efficient for the liquid waxes.

Geeignet für das Säubern des Belags in der Tiefe nach der Kantenbehandlung und nach dem Wachs als Erste Bürste. Sehr wichtig mit Flüssigwax.

Utilizzata per la pulizia della soletta in profondità dopo avere fatto le lamine e in primo dopo la sciolina. Molto importante dopo la sciolina liquida.



Brass/Nylon Brush REF. 012007

Brosse Nylon/Bronze. 2 en 1. Association des brosses 012006 et 012009.

Brass / Nylon brush. Two in one.
Nylon- und Bronzewachsbürste.
Spazzola Nylon / Bronzo. Include in un unico articolo le spazzole 012006 e 012009.



Mini Nylon Soft/Felt REF. 012074

BRASS BRUSH

Brosse bronze à poils longs et fins. Elle permet de désoxyder et de nettoyer la semelle avant le fartage. Elle est également utilisée tout de suite après le raclage pour retirer le fart en excès.
Brass brush with long and fine hairs. It allows deoxidizing and clean the base before waxing. It is also used immediately after scraping to remove the excess wax.
Bronzewachsbürste. Geeignet für das Säubern des Belags nach der Kantenbehandlung und nach dem Wachs.
Spazzola bronzo. Utilizzata per la pulizia della soletta dopo avere fatto le lamine e dopo la sciolina.

REF. 012009

REF. 012035

REF. 012020 (RED CREEK-100MM)
REF. 012053 (VOLA - 140MM)

NYLON BRUSH

Brosse nylon en polyamide à poils moyens et larges. À utiliser comme 2ème brosse après le raclage. Elle permet de polir la semelle et de lui donner un aspect le plus lisse possible afin de réduire la friction avec la neige.
Nylon brush made in polyamide with medium and long hairs. To be used in second position after the scraping. Made to smooth the base as much as possible to reduce friction with the snow.
Nylonwachsbürste. Eignet sich nach dem Wachs und nach die Bronzewachsbürste um die Skibeläge zu glätten.
Spazzola nylon. Utilizzata dopo la sciolina e dopo la spazzola bronzo per lisciare la soletta.

REF. 012006

REF. 012034
NYLON SOFT REF. 012058

REF. 012019 (RED CREEK-100MM)
REF. 012052 (VOLA - 140MM)
REF. 012061 (VOLA - SNOWBOARD)

HORSEHAIR BRUSH

Brosse à poils courts et fins. Brosse de finition à utiliser en dernière position. Sa composition en crin de cheval permet de lustrer la semelle et lui confère des qualités antistatiques qui améliorent la glisse.
Horsehair brush with short and fine hairs. Its composition will polish the base and give best gliding properties because of its antistatic qualities. To be used before the race.
Rosshaarwachsbürste. Eignet sich bevor die Rennen, um die Skibeläge zu lustrieren.
Spazzola in crine di cavallo. Utilizzata davanti la gara per lustrare la soletta.

REF. 012010

REF. 012046

REF. 012021 (RED CREEK-100MM)
REF. 012054 (VOLA - 140MM)
REF. 012067 (VOLA - SNOWBOARD)

LIÈGE / CORK / KORK / SUGHERO

REF. 012012 - LIÈGE
REF. 012055 - SYNTHETIC

ROTO BRUSH REF. 012023

FELT/CORK REF. 012011

LIÈGE / CORK / KORK / SUGHERO

REF. 012012 - LIÈGE
REF. 012055 - SYNTHETIC

ROTO BRUSH REF. 012023

FELT/CORK REF. 012011

LIÈGE / CORK / KORK / SUGHERO

REF. 012012 - LIÈGE
REF. 012055 - SYNTHETIC

ROTO BRUSH REF. 012023

FELT/CORK REF. 012011

LIÈGE / CORK / KORK / SUGHERO

REF. 012012 - LIÈGE
REF. 012055 - SYNTHETIC

ROTO BRUSH REF. 012023

FELT/CORK REF. 012011

LIÈGE / CORK / KORK / SUGHERO

REF. 012012 - LIÈGE
REF. 012055 - SYNTHETIC

ROTO BRUSH REF. 012023

FELT/CORK REF. 012011

LIÈGE / CORK / KORK / SUGHERO

REF. 012012 - LIÈGE
REF. 012055 - SYNTHETIC

ROTO BRUSH REF. 012023

FELT/CORK REF. 012011



RÉPARATION × REPAIR × AUSBESSERUNGSMATERIAL × RIPARAZIONE



Repair Pistol REF. 013018 240V / 400W / 50Hz

Pistolet de réparation grand public.
Public base repair pistol.
Consumer Repair Pistole.
Pistola Riparazione dei consumatori.

Ø Dia = 11,5mm / L = 10cm / Qty = 3pcs



Base Repair Pistol REF. 013010 220-240V / 285W

Pistolet de réparation pour l'atelier. Développée spécialement pour le naltène, sa buse permet une fonte et une application idéale de la bougie (diamètre bougie: 11.5mm).
Base repair pistol. Developed especially for the naltène, it allows a good melting and a good application of the candle (candle diameter: 11.5mm).
Belagsausbesserungspistole. Besonders für den Belagsausbesserungsstifte entwickelt, erlaubt er gutes Schmelze und eine gute Anwendung (Durchmesser: 11.5mm).
Pistola di riparazione. Sviluppato specialmente per il naltène, permette una buona fusione e una buona applicazione delle candele (candela diametro: 11.5mm).

BOUGIE / CANDLE / BELAGSAUSBESSERTSTIFTE / CANDELE



REF. 013016 - GRAPHITE
REF. 013017 - WHITE

Bougie de réparation à brûler. (x3)
P-tex candle for base repairs. To be burn. (x3)
Belagsausbesserungsstifte mit dem Feuerzeug eintropfen lassen. (x3)
Candele di riparazione, da bruciare. (x3)

Ø Dia = 8mm / L = 19.5cm / Qty = 3pcs

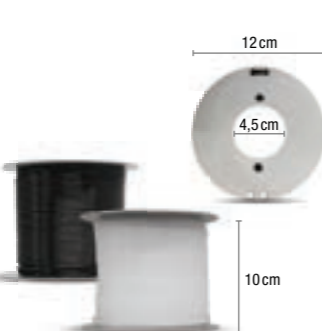

REF. 013001 - BLACK / 0.4 KG
REF. 013003 - WHITE / 0.4 KG

Bobine de réparation noire ou incolore.
Roll of P tex black or transparent.
Belagsausbesserungsdraht, schwarz oder transparent.
Bobina di riparazione nera o incolore.

Ø Dia = 3mm

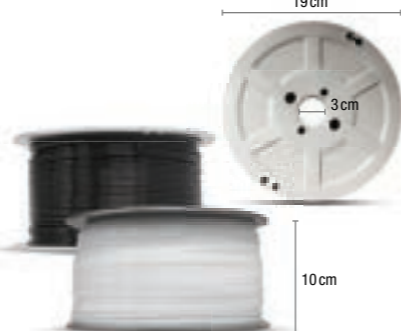

REF. 013002 - BLACK / 1.5 KG
REF. 013004 - WHITE / 1.5 KG

Bobine de réparation noire ou incolore.
Roll of P tex black or transparent.
Belagsausbesserungsdraht, schwarz oder transparent.
Bobina di riparazione nera o incolore.

Ø Dia = 3mm



REF. 013007 - BLACK 10 CANDLES
REF. 013008 - WHITE 10 CANDLES

Bougie de réparation pour pistolet.
P-tex candle for repair pistol.
Belagsausbesserungsstifte für Pistole.
Candela di riparazione per pistola.

Ø Dia = 11,5mm / L = 14,5cm



REF. 013019 - BLACK 1KG
REF. 013020 - WHITE 1KG

Bougie de réparation pour pistolet.
P-tex candle for repair pistol.
Belagsausbesserungsstifte für Pistole.
Candela di riparazione per pistola.

Ø Dia = 11,5mm / L = 14,5cm



REF. 013014 - BLACK 1KG
REF. 013015 - WHITE 1KG

Bougie de réparation à brûler.
P-tex candle for base repairs. To be burn.
Belagsausbesserungsstifte mit dem Feuerzeug eintropfen lassen.
Candele di riparazione, da bruciare.

Ø Dia = 8mm / L = 19,5cm

FERS × IRONS × WACHSBÜGELEISEN × FERRI SCIOLINATORI



Vola Iron REF. 012017
230V / 1000W / 50Hz - 120V / 800W / 60Hz

Fer à farter VOLA. Ce fer à farter est entièrement réglable et très ergonomique. Du fait de sa faible taille et de ses performances, ce fer deviendra un outil facilement transportable.
VOLA waxing iron. Completely adjustable and ergonomic. Because of its quality and small size, this iron is an easily transportable tool.
VOLA Wachsbugeleisen. Dieses Wachsbugeleisen ist völlig regulierbar und ergonomisch. Wegen seiner kleinen Größe und der hohen Leistungen ist es eine Alternative für Reisende.
Ferro sciolinatore VOLA. Interamente regolabile e molto ergonomico. Grazie alle sue dimensioni a caratteristiche è l'ideale per chi effettua frequenti spostamenti.



Digital Iron REF. 012015
230V / 1000W / 50Hz

Fer à farter digital. Contrôle de la température électronique de 0°C à 200°C.
Digital waxing iron.
Electronic temperature control with digital display from 0° to 200°C.
Digitalischer Wachsbugeleisen.
Elektronische Kontrolle der Temperatur. Von 0°C bis 200°C.
Ferro sciolinatore. Controllo elettronico preciso della temperatura. Da 0°C e 200°C.



Digital PRO Iron REF. 012068
230V / 1000W / 50Hz

Fer à farter digital avec semelle épaisse. Contrôle de la température électronique de 0°C à 200°C.
Digital waxing iron with thick sole. Electronic temperature control with digital display from 0° to 200°C.
Digitalischer Wachsbugeleisen mit dickere Sohle. Elektronische Kontrolle der Temperatur. Von 0°C bis 200°C.
Ferro sciolinatore digitale con suola spessa. Controllo elettronico preciso della temperatura. Da 0°C e 200°C.



Iron Holder REF. 012080



VOLA Roller Waxer REF. 012096

Machine à farter au rouleau. Facile à utiliser. Idéal pour l'atelier et les écoles de ski. Possibilité d'extra-bac et extra roll.
Roller waxer. Easy to use and ideal for shops and ski schools.
Wachsmaschine. Leicht zu bedienen, für Skigeschäfte und Skischulen.
Attrezzo sciolinatore a rullo. Facile da usare. Ideale per negozi e scuole sci.
220V / 1000W



Thermojomax - EXCLU VOLA

REF. 012030 - ALPINE / REF. 012031 - NORDIC 220-240V / 50Hz

Développée pour chauffer le farts sur vos semelles à la température de 60°C, la ThermoJomax permet ainsi au fart de rester à l'état liquide et d'imprégner vos semelles. À utiliser avec un fart d'imprégnation tel un MX901. Faire des cycles de chauffe d'environ 30 min pour les skis alpins et 20 min pour les skis de fond.
Developped to warm the ski base at 60°C, the ThermoJomax allows to the wax to stay at liquid state for impregnating the ski base. Recommended wax : MX901. Let it heat for 30 min for alpine skis and 20 min for nordic skis.
Die professionelle und einfache Art den Belag mit Basiswachs auf eine gute Tiefenwirkung zu bringen. Nach dem auftragen des Basiswachses mit dem Wachseisen werden die Beläge bei einer Temperatur von 60°C mit dem Thermo Jomax durchgewärmt, das Basiswachs kann dadurch tiefer in den Belag eindringen, Verbesserung der Gleiteigenschaft und Verbrennungen am Belag werden verhindert. Empfehlungen Wachs : MX901. Durchwärme ZEit ca. 30 Min für Alpin und 20 Min für Langlauf Skis.
Sviluppato per favorire la penetrazione della sciolina nella soletta, ThermoJomax riscalda lo sci fino ad una temperatura di 60°C. Sciolina raccomandata : MX901. Lasciare agire per 30 min per alpine e 20 min per sci di fondo.



TABLES DE FARTAGE × WAX TABLES × WACHSTISCHE × TAVOLI



Start Table REF. 016089 **NEW**
 Largeur/Width 20cm Longueur/Length 105cm
 Hauteur/Height 85cm

Etabli de transport Pro. Bon compromis poids / stabilité pour travailler en ski-room grâce à ses patins anti-dérapants et idéal pour les départs des courses grâce à sa légèreté.

Professional transport wax table. Good compromise weight / stability for the ski-room thanks to its skates non skid and ideal for the departures of the races, thanks to its thoughtlessness.

TTransport Wachstisch Pro. Guter Kompromiss Gewicht / Stabilität, im Workshop dank seiner rutschfesten Standfüßen sowie als an Rennstarts dank seiner Leichtigkeit.

Tavolo da trasporto Pro. Il bene compromise peso / stabilità per lavorare nel ski room grazie a sue pattine antiscivolo e ideale per le partenze delle gare grazie alla sua leggerezza.



Nordic Dual Table REF. 016076
 Poids/Weight 12kg

Table de fartage dédiée aux skis nordique, avec 2 formes skis nordiques, démontable, transportable et réglable, c'est une table idéale pour être utilisée en ski-room ou au départ d'une course.

Waxing table dedicated to Nordic skis, with 2 Nordic ski shapes, removable, transportable and adjustable, it is an ideal table to be used in the ski room or at the start of a race.

Wachstisch speziell für Nordic-Ski, mit 2 Formen für Nordic-Ski, zerlegbar, transportabel und verstellbar. Der Tisch ist ideal für den Einsatz im Ski-Raum oder am Start eines Rennens.

Tavolo da sciolinatura dedicato agli sci nordici, con 2 forme di sci nordici, smontabile, trasportabile e regolabile, è un tavolo ideale per essere utilizzato nello ski room o alla partenza di una gara.

Transportable Table REF. 016013
 Largeur/Width 10cm Longueur/Length 100cm
 Hauteur/Height 80cm Poids/Weight 5.7kg

Table de fartage de transport avec sa housse. Cette table est stable et facile à transporter. Parfaite pour les particuliers.

Transportable wax table with its transport bag. Perfect for home use. Stable and easy to carry.

Transport Wachstisch mit Hülle. Sehr stabile und einfach zu transportierende Tafel. Für Amateure sowie Kenner geeignet.

Tavolo per sciolinatura da trasporto con il suo zaino. Molto stabile e facile da trasportare. Perfetto per i lavori alla casa.



1 **Nordic Table** 016031 Poids/Weight 13kg

2 **Alpin Table** REF. 016037 Poids/Weight 8kg
 Largeur/Width 50cm Longueur/Length 115cm
 Hauteur/Height 90cm

Table de fartage Pro. Bon compromis poids/stabilité pour travailler en ski-room et idéal pour les départs des courses grâce à sa légèreté.

Wax table Pro. Good compromise weight/stability for the ski-room and ideal for the departures of the races, thanks to its thoughtlessness.

Wachstisch Pro. Guter Kompromiss Gewicht / Stabilität, im Workshop dank seiner rutschfesten Standfüßen sowie als an Rennstarts dank seiner Leichtigkeit.

Tavolo Pro. Il bene compromise peso/stabilità per lavorare nel ski room e ideale per le partenze delle gare grazie alla sua leggerezza. Tavolo da trasporto Pro. Il bene compromise peso / stabilità per lavorare nel ski room grazie a sue pattine antiscivolo e ideale per le partenze delle gare grazie alla sua leggerezza.

Nordic Light Table REF. 016075
 Poids/Weight 8kg

Table de fartage dédiée aux skis nordiques, démontable, transportable, réglable, idéale pour les départs de course ou les particuliers.

Waxing table dedicated to nordic skis, dismantlable, transportable, adjustable, ideal for race starters or individuals.

Ein Wachstisch speziell für nordische Skier, zerlegbar, transportabel, verstellbar, ideal für Rennstarts oder Amateure.

Tavolo da sciolinatura dedicato agli sci nordici, smontabile, trasportabile, regolabile, ideale per le partenze delle gare o per i privati.



Trans Air Table REF. 016011
 Largeur/Width 47cm Longueur/Length 100cm
 Hauteur/Height Adjustable Poids/Weight 22kg

Etabli démontable et râtelier. Cette table de fartage est très stable et très pratique pour les techniciens qui ont besoin d'une grande table de fartage facilement transportable dans leurs déplacements fréquents.

Wax table with rack. A very stable and practical table, ideal for the technician who needs a good table, easily transportable for travel.

Zerlegbarer Wachstisch mit Gestell. Dieser Tisch ist sehr stabil, breit und praktisch sowie leicht zu transportieren. Perfekt geeignet für Servicemänner die viel auf Reisen sind.

Tavolo smontabile con rastrelliera. Tavolo per sciolinatura molto stabile e pratico. Ideale per i tecnici che necessitano di un tavolo trasportabile per i loro spostamenti frequenti.

ÉTAUX × VISES × SKISPANNER × MORSE

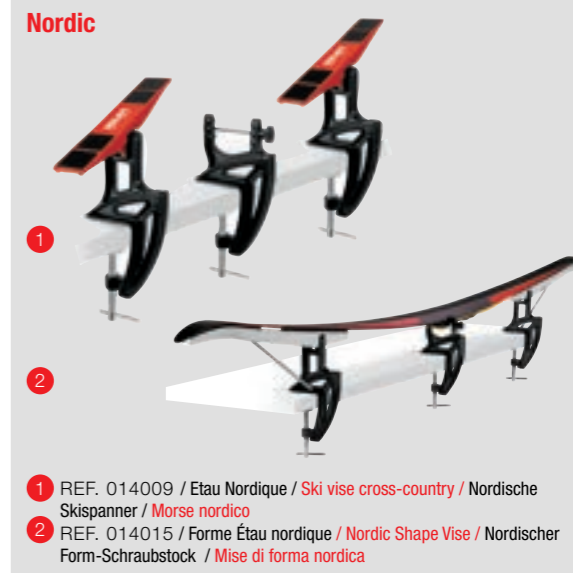

VOLA BOXES



.....DIY..... DO IT YOURSELF

Créons ensemble un kit à votre image et à vos couleurs. Échangeons sur vos besoins et attentes, prix et quantités pour façonner kit fartage et/ou affûtage.

Let's create together a kit with your image and your colors. Let's exchange on your needs and expectations, prices and quantities to shape your waxing and/or sharpening kit.

TUNING KIT ESSENTIAL

REF. 011152

SET INCLUDING:
File guide Club 88°
200mm file
Diamanded plate 600
Nylon brush
Plastic scraper 3mm
2 brake retainers



TUNING KIT PLUS

REF. 011153

SET INCLUDING:
File guide Club 88°
File 200mm
File 150 mm
Diamond plate 600
Edgerazor
Nylon Brush
Scraper 3 mm
File brush
2 break retainers



TOOL TONIC

REF. 011164

SET INCLUDING:
Edge tool
Adjustable square
File
File card
2-sided diamond file
Base level Guide 0.5°
Base level Guide 1.0°
2 brake retainers



RACE SET

REF. 011086

SET INCLUDING:
Nylon Brush
Racle Plastique
Nordic Scraper
LMach 80g Blue
LMach 80g Purple
LMach 80g Red
LMach 80g Yellow



WAXING KIT

REF. 011057

SET INCLUDING:
500g MX901
200g R021
Waxing Iron VOLA
Brass Brush
Horsehair Brush
Plastic scraper 3mm
2 brake retainers



NORDIC BOX

REF. 011061

SET INCLUDING:
200g Base Med
80g Base Graphit LMach
200g R021
Waxing Iron VOLA
Plastique Scraper 3mm
Nordic Scraper
Nylon Brush
Brass Brush



ALPINE SET

REF. 011121

SET INCLUDING:
500g MX 901
200g R021
File guide Club 88°
File 200mm
File 150mm
Vola Diamond plate 600
Waxing Iron VOLA
Nylon Brush
Brass Brush
Horse Hair Brush
File Brush
Scraper 3 mm
2 break retainers



MNT 20

REF. 011154

SET INCLUDING:
80g Base Medium
200gr MX 901
200gr R021
80g LMach Blue
80g LMach Purple
80g LMach Red
80g LMach Yellow
Waxing Iron VOLA
Edgerazor
File guide Club 88°
Base Edge
File 200 mm
File 150 mm
Nylon Brush
Brass Brush
Horsehair Brush
Vola Diamond Plate 600
Lime brush
Black Candle
Scraper 3 mm
2 Break retainers



MT 07

REF. 011060

SET INCLUDING:
200g Base Hard
200g Base Med
80g LMach Red
80g HMach Red
200g R021
125ml aerosol wax remover
Pro sidewall tool
File guide Club 88°
300mm file
200mm file
150mm file
Brass brush
Nylon brush
Horsehair brush
4 diamond plates: 200/400/600/1000
Compact Vice TRIO
Digital wax iron
File card
Scraper 3mm
2 brake retainers



NORDIC STRUCTURING TOOLS



VOLA Nordic Structuring REF. 012036

Structureuse manuelle VOLA avec rouleau interchangeable. Pratique et ergonomique, cette structureuse permet de dessiner une nouvelle structure sur les semelles de ski de fond pour améliorer la glisse. Livrée avec le rouleau «diagonal» ref 012041.

VOLA structuring device with interchangeable structure rolls. Easy to use and ergonomic, this device allows you to draw structures on the base of cross country skis. According to the snow conditions, it will increase the glide of the skis. Delivered with diagonal roll ref 012041.

VOLA Strukturroller. Leicht zu benutzen, ergonomisch Belagstrukturiergerät. Das Gerät wird mit der «Diagonal» Rolle ausgeliefert ref 012041.

Ski roll VOLA. Semplice e economico, questo prodotto è consegnato con il roll «diagonal» per nevi intermedie. È possibile di aiutare le strutture lineare e anche in «V». Venduto con il rotolo ref 012041.

V Structure



Diagonal Structure



Linear Structure



Coarse warm & wet conditions

REF. 012037 LINEAR COARSE
REF. 012040 DIAGONAL COARSE
REF. 012043 V STRUCTURE COARSE

Medium universal conditions

REF. 012038 LINER MEDIUM
REF. 012041 DIAGONAL MEDIUM
REF. 012044 V STRUCTURE MEDIUM

Fine cold conditions

REF. 012039 LINEAR FINE
REF. 012042 DIAGONAL FINE
REF. 012045 V STRUCTURE FINE

Speedy ski roller

REF. 012028
Kit A: ZIN-40 + Z2N-33 + Z1N-36

REF. 012029
Kit B: ZIN-40 + Z2N-33 + Z1N-36 + W75-24

 ZIN-40 Special H
-15°C / +3°C Groove width 0.30mm

 Z1N-36 Special H for powder snow
-17°C / +5°C Groove width 0.30mm

 Z2N-33 Special H
-6°C / +4°C Groove width 0.50mm

 W75-24 Special H
-2°C / +4°C Groove width 0.75mm



★ ★ ★

Utilisé en Coupe du Monde
par de nombreuses équipes
nationales

Used in World Cup
by many national ski teams

★ ★ ★

× 64 ×





Gloves REF. 016016

Gants pour la préparation des skis.
Gloves for ski care.
Handschuhe für die Skipräparation.
Guanti per la preparazione degli sci.

Taille / Size = 9



Cleaner paper REF. 012032

Chiffon lustrant de finition. (x20) Permet de nettoyer les semelles après le brossage.
Cleaner paper for finishing. For cleaning skis of dust after brushing. (x20)
Reinigungsvlies für die Skipräparation. (x20)
Straccio splendido per pulire dopo la spazzolatura. (x20)



Antistatic rag REF. 012069

Rouleau de chiffon antistatique.
Antistatic rag roller.
Antistatischen Tuch Rolle.
Rotolo di panno antistatico.

L = 60m / l = 17cm



Glue REF. 015010

Colle pour fixation 100ml.
Binding glue. 100ml.
Bindungsleim. 100ml.
Colla di fissaggio. 100ml.



Decameter REF. S33010-20

Décamètre. 30m. Permet de tracer un slalom en suivant les distances réglementaires.
Decameter. 30m. To be used for adjusting a slalom course in order to respect international norms.
Dekameter. 30m.
Decametro. 30m.



Profile 2 REF. 015017

Demi-masque à double filtre de qualité supérieure. Livré avec 2 cartouches ABE1P3R. Pour se protéger lors de l'application de farts solides.
Half protective mask delivered with 2 cartridges of ABE1P3R quality. To protect yourself during the application of hot waxes.
Halbmaske Doppel-Filter-Qualität. Kommt mit 2 Patronen ABE1P3R. Zum Schutz bei der Anwendung von Wachsen.
Mezza maschera di qualità doppio filtro. Viene fornito con 2 cartucce ABE1P3R. Per protezione durante l'applicazione di sciolina.

REF. 015020
Jeu de deux cartouches de rechange.
Set of two replacement cartridges.
Set bestehend aus zwei Ersatzpatronen.
Set di due cartucce di ricambio.



T-Sept REF. 015018

Equipement de protection respiratoire à ventilation assistée. Livré avec 3 cartouches ABEK2P3. Pour se protéger lors de l'application de poudres à chaud.
Protective equipment delivered with 3 cartridges ABEK2P3. To protect yourself when applying powder with a wax iron.
Schutzausrüstung PAPR. Kommt mit 3 Patronen ABEK2P3. Um sich bei der Anwendung von Pulver mit Wachsbugelisen zu schützen.
Attrezzature di protezione PAPR. Viene fornito con 3 cartucce ABEK2P3. Per proteggere se stessi quando l'applicazione di polvere a caldo.



Additif X14 REF. 013009

Additif pour eau de ponçage. Anti-oxydant, lubrifiant, dispersant, antigel. Dilution: 25 à 50%.
Additive for water of the pumicing machine. Does not oxidize, lubricates, disperses, antifreeze. Dilution: from 25 to 50%.
Zusatz zum Schleifmaschine Wasser. Oxydiert nicht, schmierend, streuend, Frostschutz. Verdünnung: von 25 bis 50%.
Aggiuntivo per acqua di sabbia. Anti-ossidando, lubrificando, disperdendo, anticongelante. Diluizione: da 25 a 50%.



Brake retainers
1 REF. 015007 / x200
2 REF. 015008 / x20

Sachet d'élastiques pour frein.
Brake retainers.
Packung Stopper-gummis.
Elastici in gomma.



PZD3 REF. 015015

Embout visseuse PZD3. 120mm.
Screwdriver PZD3. 120mm.
PZD3 Schraubendreher. 120mm.
Cacciavite PZD3. 120mm.



REF. 015013 / 3,5 * 7MM (JUNIOR SKIS)
REF. 015011 / 3,5 * 9MM
REF. 015012 / 4,1 * 9MM
REF. 015014 / 4,1 * 3,5 * 15MM (NORDIC SKIS)

Forets / Bit / Bohrer / Punteruolo

Snow marker REF. 017006

Coloneige. Disponible en 1L, 5L et 20L. Pour les pistes de vitesse ou tout type de tracé pour marquer des mouvements de terrain.
Snow marker. Available in 1L, 5L and 20L. Made for the downhill slopes or every kind of race in order to see the slope movements.
Schneecontrastmittel. 1L, 5L und 5L. Gemacht für Abfahrt.
Colore. 1L, 5L e 20L. Venduto per le discipline di velocità e tutte le gare per vedere il rilievo.



De-freezing REF. 017003

Déglaçant mécanique. 5L. (peut être livré en 20L)
Facile d'utilisation, non toxique, non corrosif. Permet de débloquer toutes pièces bloquer par la glace telles que des glissières de téléskis, de cableries diverses, d'axes, articulations, paliers, roues, etc...
Mechanical de-freezing. 5L. (can be delivered in 20L bottle too) Easy to use, not toxic, does not oxidize. Allows to unlocked mechanical pieces of ski lift blocked by the ice such as wheels, axis, flexes...
Mechanischer Frostentferner. 5L. Einfache Bedienung, nicht toxisch, nicht korrosiv. Wird der Frost lösen und die Bewegung der Teile wieder ermöglichen. Einsatzbeispiele: Schilift Gleitfläche, Seilen, Achsen, Gelenke, Lager, Räder, usw.
Sghiacciatore meccanico. 5L. (E possibile di avere anche in 20L) Facile da utilizzare, non tossico, non corrosivo. Permette di sbloccare tutti i pezzi bloccati dal ghiaccio come giunti, cuscinetti, ruote, ecc.



REF. 015006 x1000
Chevilles plastiques.
Plastic hole plugs.
Plastikpfropfen für Bohrlöcher.
Tassello plastica.
Ø Dia = 4.5 mm



REF. 015005 x100
Insert plastique.
Plastic inserts.
Plastikdübel.
Inserto in plastica.
Ø Dia = 9 mm



REF. 015004 x100
Insert laiton.
Brass inserts.
Eindreh-Messingensätze.
Inserto ottone.
Ø Dia = 8.5 mm

REF. 016015
Rouleaux de scotch VOLA.
VOLA Tape large.
Klebebänderolle Breit.
Nastro adesivo VOLA grande.



REF. 016014
Rouleaux de scotch VOLA fin.
VOLA Tape fine.
Klebebänderolle Fein.
Nastro adesivo VOLA fino.



REF. 016030
Scotch papier VOLA.
VOLA Tape paper.
Papier Klebebänderolle Breit.
Nastro adesivo VOLA.



Thermometer

Thermomètre / Hygromètre électronique. Livré avec sonde.
Thermometer / Hygrometer electronic. Delivered with a probe.
Thermometer / Feuchtigkeitsmesser elektronisch. Mit einer Sonde geliefert.
Termometro / Igrometro elettronico. Fornito con una sonda.

REF. 016018 / MINI -20°C



REF. 016019 / PRO



REF. 016018 / MINI -20°C

Thermometer

Thermomètre / Hygromètre électronique. Livré avec sonde.
Thermometer / Hygrometer electronic. Delivered with a probe.
Thermometer / Feuchtigkeitsmesser elektronisch. Mit einer Sonde geliefert.
Termometro / Igrometro elettronico. Fornito con una sonda.



ACCESSORIES & MERCHANDISING



Petite mallette (vide) **Small box** (empty)
REF. 011069
Longueur/Length 27 Largeur/Width 23 Hauteur/Height 5cm



Mallette large (vide) **Large box** (empty)
REF. 011070
Longueur/Length 33 Largeur/Width 28 Hauteur/Height 12cm



Mallette XL (avec mousse de calage)
XL box (with cushioning foam)
REF. 011101
Longueur/Length 53 Largeur/Width 40 Hauteur/Height 17 cm



Trousse (vide) **Kit** (empty)
REF. 016057
Capacity 5L
Longueur/Length 27 Largeur/Width 12 Hauteur/Height 17cm



Talkie-walkie holder REF. 016085



Key-holder REF. 016024



Straps
① **Alpine** REF. 016006
② **Nordic** REF. 016007
③ **Nordic small** REF. 016025



Vola Slope Flag REF. 016053
Largeur/Width 30 cm Hauteur/Height 40 cm



Mini-Flag REF. 016061
Hauteur/Height 40cm



Cardboard Display REF. 016067
Largeur/Width 25 Longueur/Length 31 Hauteur/Height 52cm
Présentoir vendu sans produit / Display sold without product



Tent REF. 016050
Largeur/Width 3m Longueur/Length 3m = 9m²

PERSONNALISATION

Créons ensemble des produits qui vous ressemblent.

De la mallette farts/accessoires, aux scratchs pour skis, en passant par des blocs de farts avec étiquettes logotées, nous avons une multitude de produits pouvant être personnalisés à votre enseigne, team ou événement. N'hésitez pas à nous contacter pour plus d'informations.

CUSTOMIZATION

Let's create together products that look like you.

From the wax/tools case, to the strap for skis, through the waxes with logoted labels, we have a multitude of products that can be personalized to your brand, team or event. Do not hesitate to contact us for more information.



Roll up REF. 016044
Largeur/Width 60cm Hauteur/Height 2m



Metal Display REF. 016068
Largeur/Width 45 Longueur/Length 60 Hauteur/Height 2.10m
Présentoir vendu sans produit / Display sold without product



Banner REF. 016042
Largeur/Width 70 Longueur/Length 3m



Apron REF. 016008



Flag Black or White REF. 016043
Largeur/Width 70cm Hauteur/Height 3.5m





© Agence Zoom

© KFRN

EQUIPMENT

2024 - 2025

#FLY TO SUCCESS



ARGENTINA
The Outdoor Company
Matias Grebenar
Km 40 Ramal Pilar of C4
1669 Pilar Buenos Aires
@ info@outdoorcompany.com.ar
☎ +54 348 46 39 997
✉ +54 11 3169 2777

ANDORRA
Oxigen Distribucions, s.l.
Ctra. Dels Cortals
Rcial. Cortals Baixos
AD200 Encamp
PRINCIPAT D'ANDORRA
@ info@oxigen.ad
☎ +376 832560
✉ +376 343945

AUSTRIA
Life Sport Product's Gmbh
Bahnhofstrasse 46
4810 GMUNDEN
@ office@lsp-austria.at
☎ +43 76 12 70 777

BELGIQUE
Altitude 0
83, Chaussée de Waterloo
B-5002 NAMUR
@ philippe.willems@altitudezero.be
☎ +32 81 73 76 43
✉ +32 495.500607

BULGARIA
Alpin Eood
Iztok str. Samokov 28-Z
Office 1
1113 SOFIA
@ descentebg@gmail.com
☎ 00359 2 892 0202
✉ +359888614684

CANADA
Distribution Des Monts
162, Des Monts
ST SAUVEUR - QUÉBEC
jOr 1r5
@ distributiondesmonts@gmail.com
☎ 450-227-0802

CHILE
Ski Nautica
Av Las Condes
7735 LAS CONDES
SANTIAGO
@ contacto@skinautica.cl
☎ +56 2711 8065

CHINA
Yueqing Wharton Int. Trading Co
Room 1103, NO.3, Chenmu Garden
District, YUEQING CITY
325600 ZHEJIANG
@ andy@wharton-china.com
☎ +86 57761513377

CZECH REPUBLIC
Tomáš Tuček - STEATIT
Kosmonautů 324
530 09 PARDUBICE
@ info@volaracing.cz
☎ +420 606 929 043
✉ www.volaracing.cz

VOLA ESPAÑA
Avenida de Francia, 16
17520 Puigcerda
@ sales@vola-racing.es
☎ +34 609 750506
✉ www.vola.fr

ESTONIA
Rendikeskus Oü
Jaanus Lõvi
Ranniku tee 1a,
Rannamõisa küla, 76906
@ info@rendikeskus.ee
☎ 372 52 72 999

FINLANDE
Mankkaan Suksihuolto Oy
Sinikalliontie 4
02630 ESPOO
@ info@mankkaansuksihuolto.com
☎ +358 50 304 3994

GEORGIE
DV Sport Ltd / David Razmade
3 Beliashvili Str ; Digomi
01 TIBLISSI
@ dvsport@dvsport.ge
☎ +995 32 21 83 339

GERMANY
VOLA RACING.CH
@ karl@vola-racing.ch
☎ +41 79 253 48 73

FRANCE
Vola Racing / Factory
37, avenue de Saint-Martin
BP52, F-74190 PASSY
www.vola.fr
@ vola@vola.fr
☎ +33 4 50 47 57 20

GREAT BRITAIN
Ski Bitz
8, Glenwood avenue
PO22 8BS WEST SUSSEX
@ sales@ski-bitz.co.uk
☎ +44 779 525 5110

GREECE
Board Generation
27-29 Garefi Str.
11525 Neo Psychiko ATHENS Greece
@ boardgen@otenet.gr
☎ +30 2106713879
✉ www.boardgeneration.com

IRAN
Pamchal Sport
38th st., Asadabadi St,
14366 TEHRAN
@ pamchalgroup@gmail.com
☎ 0098-21-88062663
0098-912-2769896
✉ +98 (0) 21 880 630 92

ITALIA
Confsport / Energiapura
Via Jolanda 59
36056 STROPPARI DI TEZZE SUL BRENTA
@ sales@energiapura.info
☎ +39 0424 539435

JAPON
Big M Snow Plan
2-8-8 1gou, Mino,
Kawanishi-shi
Hyogo, Japan 666-0105
@ info@bigm-snowplan.com
☎ +81-72-746-7582

LATVIA
LTD JANIUS Gales Iela 27
LV2150 SIGULDA
@ info@siguldasdzains.lv
☎ +371 26668089
✉ www.volaracing.lv

LEBANON
Pic Blanc Sport
Zoghaib Building - Faraya Road
Po Box / Reyfoun 85
MAYROUBA (Kesrouane)
@ anthony@picblancsports.com
☎ 961 9 330121

LIECHTENSTEIN
EDGE&BASE
Speedmax.li Est.
Palduinstrasse 52
9496 BALZERS
@ info@edgeandbase.com
☎ +423 786 60 01
✉ www.edgeandbase.com

LITHUANIA
PROSPORT.LT
Vandziogalos str. 94
47467 KAUNAS
@ info@prosport.lt
☎ +370 672 70159

NETHERLANDS
Vola Netherlands
Rijksweg 198
6247 AN Gronsveld
@ info@volawax.nl
☎ +31(0)85-060 3663
✉ www.volawax.nl

NEW ZEALAND
Bobo Products Ltd
5 Ross Street PO Box 43
Darfield 7510, Canterbury
@ gerald@bobo.co.nz
☎ 03 317 9096
✉ 03 317 9095

NORWAY
Sport Alpin As
Gladvollveien 7G
1168 OSLO
@ espen@sportalpin.no
☎ +47 905 011 16

POLAND
Malczewski Sport
Marcin Malczewski
ul.Oberconiuwka 26a
34-500 ZAKOPANE
@ malczewskisport@gmail.com
☎ +48 609 603 034
✉ www.malczewskisport.pl

ROMANIA
Sc Alpin Ski Sport Arieseni Srl
Sat. Bubesti, Nr 88A,
com Arieseni, jud. Alba,
517040 ARIESENII 88A
@ contactalpinski@yahoo.com
☎ +40 744 322 071
✉ +40 733 011 350

RUSSIA
DSS, Ltd.
Drezdenskaya Street,
case 8 / building 2,
194017 SAINT PETERSBURG
@ e@dss-piter.ru / a@dss-piter.ru
☎ (812) - 293-06-77
(812) - 293-06-78
✉ (812) - 293-11-37

SLOVAKIA
TT SPORT SK, s.r.o.
Trieda SNP 342/96
040 11 KOŠICE
@ info@volaracing.com
☎ +421 (0)949 138 648
✉ www.volaracing.com

SOUTH-KOREA
Himazone
6-19 Gyeongchun-ro 227beon-gil
Guri-si Gyeonggi-do 11926
@ kish7911@gmail.com
☎ +82 31 566 2336

SWITZERLAND
VOLA Racing.ch
Route de Chandoline 27B
1950 Sion 4
@ sales@vola-racing.ch
☎ Suisse Romande : 027 203 03 30
☎ Deutsche Schweiz : 079 253 48 73
✉ www.vola-racing.ch

UKRAINE
Ecopolis West Ltd
Krasivskogo Str. 3-A
76018 Ivano - Frankivsk
@ volaracingua@gmail.com
☎ +38 0342 55 28 40
✉ www.vola.com.ua

USA
Reliable Racing
643 Glen Street
Queensbury, NY 12804
@ info@reliableracing.com
☎ +1 800 223 4448
✉ www.reliableracing.com

Shop Tek Inc. - DBA Ski Kare
5375 Orchard Street
80403 Golden Colorado
@ gifford@central.com
☎ +1 303 278 3828

**ECO TEXTILE CARE
UNDERWEARS
LIFESTYLE
HELMETS
GOGGLES
SUNGLASSES
POLES**



ECO TEXTILE CARE BORN TO BE FREE



VOLA

x D x

TEXTILE CARE

97%

d'ingrédients
d'origine naturelle.
of natural
ingredients.



Wash

Ref 990700 250ml/8.5(fl)oz
Ref 990800 1L/33.8(fl)oz

La lessive
The detergent

90%

de matières premières
biodégradables.
of biodegradable raw materials.



Proof SPRAY

Ref 991601 150ml/5(fl)oz
Ref 991701 250ml/8.5(fl)oz

L'imperméabilisant
The waterproofing

75%

de matières premières
biodégradables.
of biodegradable raw materials.



Proof MACHINE

Ref 991700 250ml/8.5(fl)oz
Ref 991800 500ml/17(fl)oz

L'imperméabilisant
The waterproofing

96%

biodégradable.
biodegradable.



Fresh

Ref 992601 Spray 150ml/5(fl)oz
Ref 992800 Machine 500ml/17(fl)oz
Ref 992900 Machine 5L/169(fl)oz

Le désodorisant
assainissant
The deodorizer sanitizer

97%

d'ingrédients d'origine
naturelle.
of natural ingredients.



Soap

Ref 990100 200g/7oz

Le détachant
The stain remover

Scannez les QR Codes

& découvrez les défis lancés à Fab et Enak !
Ils ont mouillé le maillot pour tester la
véracité des produits VOLA-Éco Textile Care.

Seulement en Français / Only in French

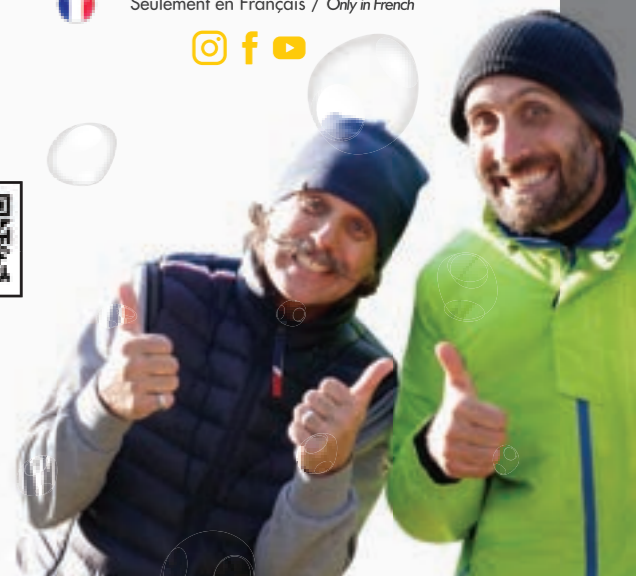

x E x

Bienvenue Welcome

Notre gamme Eco Textile Care a été développée dans le respect de l'environnement et des utilisateurs. Nous avons tenu à travailler sur l'impact de nos produits à chaque étape du cycle de vie, afin qu'ils soient le plus respectueux de l'homme et de la nature. Classés non dangereux, sans pictogramme de danger, ces produits ont été testés et approuvés pour vous apporter la plus grande satisfaction.

L'ensemble de la gamme Eco Textile Care est conçue et fabriquée en France, par (et pour), des passionnés de grands espaces et de performances.

Our Eco Textile Care range has been developed with respect for the environment and users. We have worked on the impact of our products at each stage of the life cycle, so that they are the most respectful of man and nature. Classified as non-hazardous, with no danger pictograms, these products have been tested and approved to bring you the greatest satisfaction.

The entire Eco Textile Care range is designed and manufactured in France, by (and for) people who are passionate about open spaces and performance.



TEXTILE CARE - TESTS



Proof SPRAY

Imperméabilisation / Waterproofing

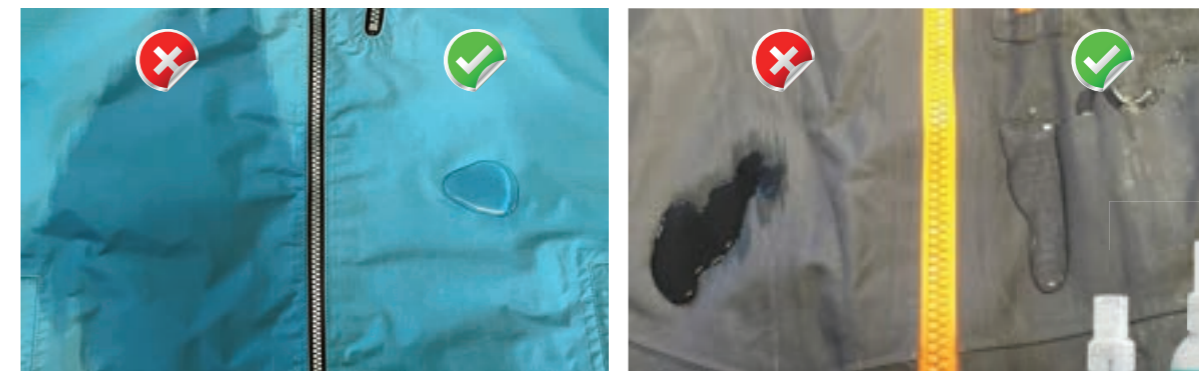

▲ Nous avons appliqué le Proof Spray sur les parties droites des vestes. Puis, nous avons déposé 10ml d'eau sur chaque côté.

Résultat: l'eau s'imprègne sur le côté gauche alors que, sur le côté droit, (qui est imperméabilisé) l'eau reste en surface !

We applied the Proof Spray to the right sides of the jackets. Then, we put 10ml of water on each side.

Result: the water soaks in on the left side, while on the right side, which is waterproofed, the water stays on the surface!



Tests des produits sur différents tissus / Product testing on different fabrics



Soap + Wash

Détachant et lessive / Stain remover and detergent



◀ Le pant' à Jo. Ce pantalon, c'est celui de Jonathan, un collaborateur de VOLA qui travaille à la production des farts. Ces tâches, c'est de la cire, des résidus et d'autres matières.

Nous avons appliqué le Soap et frictionné énergiquement les tissus. Puis, nous avons mis le pantalon en machine avec la lessive Wash. Le résultat est bluffant !

Jo's pants. These pants are those of Jonathan, a VOLA employee who works in wax production. These stains are wax, residues and other materials.

We applied the Soap and rubbed the fabrics energetically. Then we put the pants in the machine with the Wash detergent. The result is amazing!



UNDERWEAR

Collection



TOP



FONCTIONS

- Respirabilité / **Breathability**
- Structure 3D, transport d'humidité / **Moisture Transport 3D structure**
- Lignes de stabilité WRAP_pro / **Stability Lines WRAP_pro**
- Soutien / **Support**
- Isolation / **Insulation**

UNISEX TOP

| | |
|-------------|----------|
| Size | |
| XS | U1020XS |
| S-M | U1020SM |
| L-XL | U1020LXL |

76% Polyamide, Polyamide, Polyamid, Poliammide
 19% Polypropylène, Polypropylene, Polypropylen, Polipropilene
 5% Elastan, Elastan, Elastan, Elastan



DRYTOP

Le Drytop est une fibre de tissu de haute technologie, très douce, qui absorbe l'humidité de la peau et qui l'évacue vers l'extérieur. Le système garde la peau agréablement sèche et protège le corps contre le refroidissement pendant les pauses.
 Drytop is a very soft high-tech yarn that absorbs moisture from the skin and evacuates it to the outside. Keep skin pleasantly dry. Protects the body against cooling during breaks, increases wearing comfort and dries quickly.

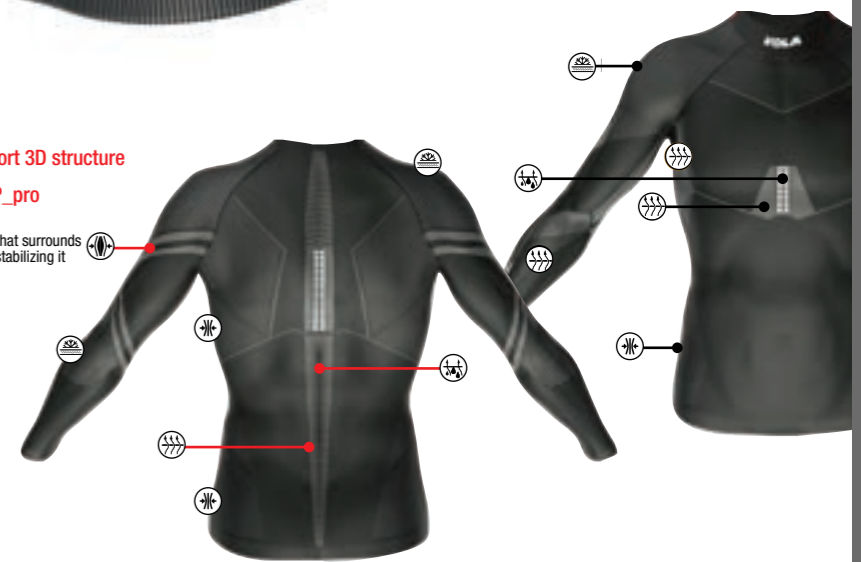

PANT



FONCTIONS

- Respirabilité / **Breathability**
- Structure 3D de transport d'humidité / **Moisture Transport 3D structure**
- Lignes de stabilité WRAP_pro / **Stability Lines WRAP_pro**
- Soutien / **Support**
- Isolation / **Insulation**

UNISEX PANT

- Size**
XS U2020XS
S-M U2020SM
L-XL U2020LXL

76% Polyamide, Polyamide, Polyamid, Poliammide
 19% Polypropylène, Polypropylene, Polypropylen, Polipropilene
 5% Elastan, Elastan, Elastan, Elastan



× J ×

SOCKS



FONCTIONS

- Respirabilité / **Breathability**
- Soutien / **Support**
- Protection / **Protection**

UNISEX SOCKS

- Size**
35-36 U302035
37-38 U302037
39-41 U302039
42-44 U302042
45-47 U302045

63% Polyamide, Polyamide, Polyamid, Poliammide
 8% Polypropylène, Polypropylene, Polypropylen, Polipropilene
 3% Elastan, Elastan, Elastan, Elastan
 3% Laine de Soie, Silk Wool, Seidenwolle, Lana Setaw



La forme ergonomique de la voûte plantaire Dry-Airy a été conçue pour le pied droit et gauche. Cette semelle amortit les principaux points de charge et garantit une excellente ventilation du pied. **The ergonomic shape of the Dry-Airy insole has been designed for the right and left foot. It dampens the main charging points and guarantees excellent ventilation on the foot.**

× K ×

PACK #1

PACK #2

ESSENTIEL PACK

OPTIMAL PACK



- TOP / LONG SHIRT
XS x 3
S-M x 6
L-XL x 6
Total = 15 pcs



- COLLANT / PANTS
XS x 1
S-M x 2
L-XL x 2
Total = 5 pcs



- CHAUSSETTES / SOCKS
35-36 x 6
37-38 x 6
39-41 x 12
42-44 x 12
45-47 x 6
Total = 42 pcs



Fourni avec le PACK #1:
1 présentoir métall blanc

Supplied with pack 1:
1 white metal display

Spécifications du présentoir:
Présentoir métallique blanc
Suspensions sur la partie haute
3 étagères sur la partie basse
Sur roulettes
Profondeur: 45cm
Largeur: 60cm
Hauteur: 2m10

Possibilité de mettre d'autres
produits VOLA sur les étagères
disponibles.

Display specifications:
White metallic display
Suspensions on the upper part
3 shelves on the lower part
On casters
Depth: 45cm
Width: 60cm
Height: 2m10

Possibility to put other VOLA products on the
available shelves.



- TOP / LONG SHIRT
XS x 6
S-M x 12
L-XL x 12
Total = 30 pcs



- COLLANT / PANTS
XS x 2
S-M x 4
L-XL x 4
Total = 10 pcs

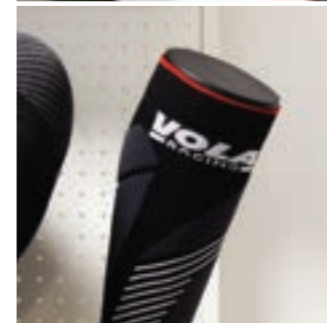

- CHAUSSETTES / SOCKS
35-36 x 6
37-38 x 12
39-41 x 21
42-44 x 21
45-47 x 6
Total = 66 pcs

Fournis avec le PACK #2:
1 présentoir métall blanc
+ 1 présentoir chaussette
+ 1 buste

Supplied with pack 2:
1 white metal display
 1 sock display
 1 bust

Les quantités ne sont pas
flexibles. Le calcul a été fait
sur la base d'une moyenne
par personne et par an de:
2 tops + 1 collant + 4 paires
de chaussettes.

Quantities are not flexible. The calcu-
lation has been done based on the
average per person is 2 tops 1 pant
 4 socks per year.





LIFESTYLE



Winter Bag REF. 016081
Capacity 65L
Largeur/Width 30 Longueur/Length 45 Hauteur/Height 55cm



Mountain Bag REF. 016059
Capacity 20L
Largeur/Width 15 Longueur/Length 25 Hauteur/Height 45cm



Soft Bag REF. 016009
Capacity 30L
Largeur/Width 20 Longueur/Length 35 Hauteur/Height 50cm



Sweater Black
REF. 016055 UNISEXE
XS / S / M / L / XL / XXL



Zipped Sweater Gray
REF. 016086 UNISEXE **NEW**
XS / S / M / L / XL / XXL



Tee-Shirt Black
REF. 016077 UNISEXE
XS / S / M / L / XL / XXL



1 **Waist Bag** REF. 016027 Capacity 0,5L
2 **Metal Bottle** REF. 016069 Capacity 0,75L
3 **Thermobelt** REF. 016082 Capacity 1L



Caps
REF. 016072 **Athletic**
REF. 016071 **Classic**



Hats
REF. 016087 **Black**
REF. 016088 **Bordeaux**



Neckwarmers
1 REF. 016083 **Black**
2 REF. 016084 **Blue**
Scarfs
3 REF. 016074 **Stars**
4 REF. 016073 **Corporate 2**

× O ×





FIS Carbon helmet



+ livré avec boîte de transport rigide
 / Homologué FIS
 / Coque Carbone + système multicouche d'absorption des chocs
 / Mousse confortables et amovibles
 / Accroche masque en caoutchouc souple
 / Norme CE EN1077:2007 Classe A (Europe)
 / Norme US ASTM 2040
 / Tailles S (54) / M (56) / L (58) / XL (60) / XXL (62)

+ delivered with rigid transport box
 / FIS homologated
 / Carbon Shell + Black EPS Impact-Absorbing Liner
 / Removable Comfortable Padding
 / With Goggle Retainer
 / CE Norm EN1077:2007 Classe A (Europe)
 / US Norm ASTM 2040 Norm (US)
 / Sizes S (54) / M (56) / L (58) / XL (60) / XXL (62)

ELEMENT 6
CARBON KEVLAR REF. P1028E



FIS + Mips helmet

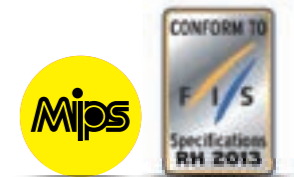

/ Homologué FIS
 / Coque ABS + système multicouche d'absorption des chocs
 / système breveté MIPS d'absorption des chocs
 / Mousse confortables et amovibles
 / Accroche masque en caoutchouc souple
 / Norme CE EN1077:2007 Classe A (Europe)
 / Norme US ASTM 2040
 / Tailles S (54) / M (56) / L (58) / XL (60) / XXL (62)

/ FIS homologated
 / ABS Shell + Black EPS Impact-Absorbing Liner
 / MIPS registered system for more shock absorption
 / Removable Comfortable Padding
 / With Goggle Retainer
 / CE Norm EN1077:2007 Classe A (Europe)
 / US Norm ASTM 2040 Norm (US)
 / Sizes S (54) / M (56) / L (58) / XL (60) / XXL (62)

Onyx REF. P1018O
 Mat and shiny texture



MIPS correspond à «Multi-directional Impact Protection System». Sa fonction principale est de réduire les forces de rotation causées par certains coups portés à la tête. Développée par des neurochirurgiens et par d'autres scientifiques, cette technologie s'est avérée efficace dans la réduction des impacts sur votre cerveau causés par les chocs obliques.

MIPS means «Multi-directional Impact Protection System». Its main function is to reduce the rotational forces caused by certain blows to the head. Developed by neurosurgeons and other scientists, this technology has proven to be effective in reducing the impacts on your brain caused by oblique shocks.





FIS helmet



- / Homologué FIS
- / Coque ABS + système multicouche d'absorption des chocs
- / Mousses confortables et amovibles
- / Accroche masque en caoutchouc souple
- / Norme CE EN1077:2007 Classe A (Europe)
- / Norme US ASTM 2040
- / Tailles XS (50) / XS (52) / S (54) / M (56) / L (58) / XL (60) / XXL (62)

- / FIS homologated
- / ABS Shell + Black EPS Impact-Absorbing Liner
- / Removable Comfortable Padding
- / With Goggle Retainer
- / CE Norm EN1077:2007 Classe A (Europe)
- / US Norm ASTM 2040 Norm (US)
- / Sizes XS (50) / XS (52) / S (54) / M (56) / L (58) / XL (60) / XXL (62)



FIS Radiation P1013R **NEW**



FIS Peeps P1013P **NEW**



FIS Speed P1012S



FIS Genesis P1013G **NEW**

MIPS > 54/56/58/60/62
No-MIPS > 50/52



CO-BRANDING
VOLLA &
ENERGIAPURA
HELMET

P4001M
Mentonnière pour casques FIS VOLLA. Taille unique / couleur noir.
Non disponible pour les tailles 50-52.
Chinguard made for VOLLA FIS helmets. One size fits all / black color.
Note available for 50-52 sizes.





SENTINEL helmet

/ Coque ABS + système multicouche d'absorption des chocs.
 / Mousses et oreilles confortables et amovibles.
 / Inserts pour mentonnière.
 / Oreilles renforcées pour une protection optimale.
 / Norme CE EN1077:2007 Classe B (Europe).
 / Norme US ASTM 2040
 / Tailles S(51-54) / M(55-58) / L(59-61)

/ ABS Shell + multilayer shock absorption system.
 / Comfortable and removable foams and ears.
 / Inserts for chinguard.
 / Reinforced ears for optimal protection.
 / CE Norm EN1077:2007 Classe B (Europe)
 / US ASTM 2040 Norm (US)
 / Sizes S(51-54) / M(55-58) / L(59-61)



Sentinel Obscure P3230



NEW
Sentinel Green P324G



NEW
Sentinel Crystal P324C



NEW
Sentinel Red P324R



NEW
Sentinel Action P324A



NEW
Sentinel Genesis P324E

CO-BRANDING
VOLA &
ENERGIAPIURA
 HELMET



P5000J - JUNIOR - pour casques taille S / For helmets size S
 P5000U - SENIOR - pour casques taille M et L / For helmets size M & L

Mentonnière pour casques Sentinel VOLA. Couleur noir.
 Chinguard made for VOLA Sentinel helmets. Black color.



x U x



Wideeyes

4 encoches pour une tenue optimale.
4 notches for an optimal hold.



2 clips de chaque côté du masque pour verrouiller l'écran.
2 clips on each side of the goggle to lock the lens.



3 aimants pour faciliter la mise en place de l'écran.
3 magnets to facilitate the installation of the lens.

RevealLine

Champ de vision XXL associé aux écrans HQ RevealLine.
XXL field of view in combination with HQ RevealLine lenses.

WIDEYES goggle



/ Livré avec un écran supp Pink + un goggle cover microfibre + un étui rigide.
/ Écran cylindrique pour un minimum de distorsion visuelle.
/ Champ de vision XXL.
/ Système de changement d'écran sécurisé et fonctionnel grâce à l'association clips + aimants.
/ Finition brillante / 100% UV400.
/ Monture course en polyuréthane souple qui s'adapte aux différentes formes de casques.
/ Double écran polycarbonate traité anti-buée.
/ 3 vagues de silicone au dos de l'élastique permettent une meilleure adhérence.
/ Épaisseur de la mousse 15mm = mousse triple densité.
/ Mousse compressée autour du nez pour une meilleur respiration.
/ Confort et sécurité Directive 2016/425 European Standard EN 174: 2001- Ski goggles for downhill skiing.

/ Delivered with an additional Yellow spare lens + a goggle cover + a rigid EVA box.
/ Cylindrical screen for minimum visual distortion.
/ XXL field of vision.
/ Secure and functional screen changing system thanks to the association of clips + magnets.
/ Shiny finition / Lens are 100% UV400 protection.
/ Shape in soft polyurethane which fits well with different types of helmets.
/ Double polycarbonate lenses.
/ 3 silicon waves at the back of the straps for a good adhesion.
/ Foam thickness 15mm. Triple density foam.
/ Foam compressed around the nose for better breathing.
/ Comfort and safety Directive 2016/425 European Standard EN 174:2001-Ski goggles for downhill skiing



NEW
Wideyes Red P7502-R
Livré monté avec écran Red.
Delivered assembled with Red lens.



Wideyes Blue P7501-B
Livré monté avec écran Red.
Delivered assembled with Red lens.



Wideyes Black P7501-N
Livré monté avec écran Red.
Delivered assembled with Red lens.



Wideyes White P7501-W
Livré monté avec écran Red.
Delivered assembled with Red lens.

RevealLine

DESIGNED TO FIND THE PERFECT LINE

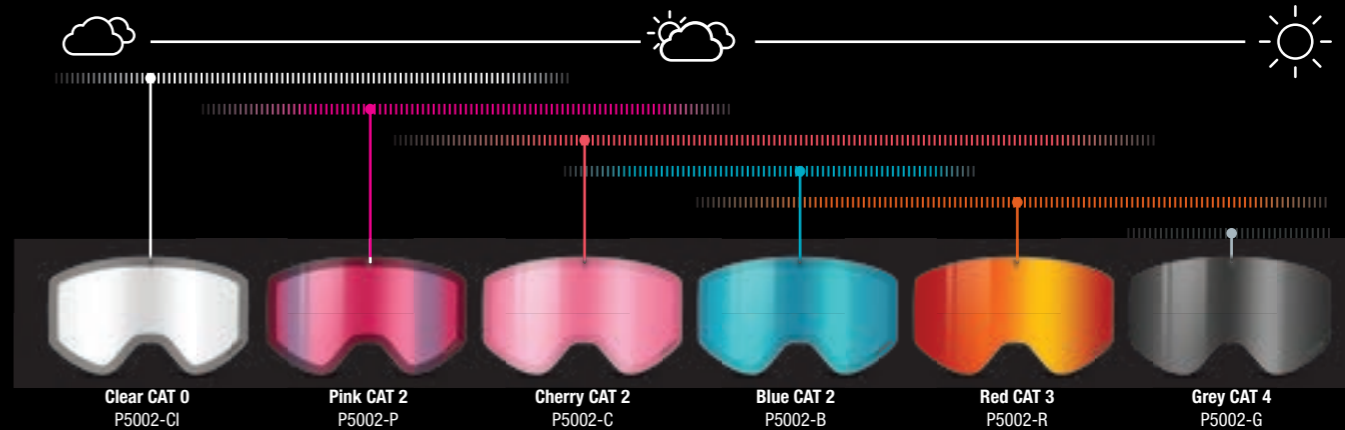

La **Technologie Revealine** combine plusieurs années de tests sur les terrains de la Coupe du Monde afin d'obtenir les meilleures combinaisons de couleurs d'écrans et irridium. L'objectif principal: augmenter au maximum les contrastes dans toutes les conditions météorologiques. Cette expertise couplée à une qualité d'écrans HQ permet une vision claire et précise de là où vous mettez vos spatules.

The **Revealine Technology** combines several years of testing on World Cup slopes to obtain the best combinations of lenses colours and irridium. The main objective: to increase the contrast as much as possible in all weather conditions. This expertise coupled with the quality of lenses HQ allows a clear and precise vision of where you put your skis.





FAST goggles

/ Livré avec un verre supp Pink et 1 sac de protection microfibre
 / Finition brillante / Indice de protection catégorie 3. UV400
 / Monture course en polyuréthane souple qui s'adapte aux différentes formes de casques
 / Double écran polycarbonate traité anti-buée
 / Teinte des verres FULL REV0 pour un effet miroir multicolor
 / 3 vagues de silicone au dos de l'élastique permettent une meilleure adhérence
 / Épaisseur de la mousse 15mm. Mousse triple densité
 / Confort et sécurité Directive 2016/425 European Standard EN 174: 2001-Ski goggles for downhill skiing

/ Delivered with an extra Pink lens and a microfibre protection bag
 / Shiny finition / Lens are 100% UV400 protection
 / Racing shape in soft polyurethane which fits well with different types of helmets
 / Double polycarbonate lenses with anti-fog treatment
 / Lens treatment: FULL REV0 coating, (from different directions, the lens show the same color)
 / 3 silicon waves at the back of the straps for a good adhesion
 / Foam thickness 15mm. Triple density foam
 / Comfort and safety Directive 2016/425 European Standard EN 174: 2001-Ski goggles for downhill skiing



FAST Grey P7700-Y **NEW**



FAST Graf P7700-F **NEW**



FAST Lines P7700-L **NEW**



FAST Pacific P7600-P

Écrans / Lenses



× X ×

× Y ×





INNOVITY goggle

/ Livré avec un sac de protection microfibre
 / Finition brillante / 100% UV400
 / Accroche des verres se faisant à l'aide d'aimant pour un remplacement simple et rapide
 / Monture en polyuréthane souple qui s'adapte aux différentes formes de casques
 / Double écran polycarbonate traité anti-buée
 / Teinte des verres FULL REVO pour un effet miroir multicolore
 / 3 vagues de silicone au dos de l'élastique permettent une meilleure adhérence
 / Épaisseur de la mousse 15mm. Mousse triple densité
 / Confort et sécurité Directive 2016/425 European Standard EN 174: 2001- Ski goggles for downhill skiing

/ Delivered with a microfiber protection bag
 / Shiny finish / Lens are 100% UV400 protection
 / Lens hold with magnet for a quick and easy replacement.
 / Shape in soft polyurethane which fits well with different types of helmets
 / Double polycarbonate lenses with anti-fog treatment
 / Lens treatment: FULL REVO coating
 / 3 silicon waves at the back of the straps for a good adhesion
 / Foam thickness 15mm. Triple density foam
 / Comfort and safety Directive 2016/425 European Standard EN 174: 2001-Ski goggles for downhill skiing



Masque complet / Full goggle



Agility P7404-A
 Deliverable with Blue lens

Shade P7404-S
 Deliverable with Silver lens

Texture P7404-T
 Deliverable with Silver lens

Sweety P7403-S
 Deliverable with Black lens

INNOVITY

16 interchangeable straps / 5 magnetic lenses
CREATE YOUR STYLE, CREATE YOUR LIFE

Strap à l'unité / Single strap



Strap Agility
 P4005N-A

Strap Shade
 P4005N-S

Strap Texture
 P4005N-T

Strap Sweety
 P4004N-S

Strap Icy
 P4004N-I

Strap Passion
 P4004N-P

Strap Pur
 P4003N-P

Strap Legend
 P4003N-L

Strap Shadow
 P4003N-S

Strap High
 P4003N-H

Strap Paint
 P4002N-P

Strap Galaxy
 P4002N-G

Strap Palms
 P4002N-A

Strap Speed
 P4002N-S

Strap Pink Crystal
 P4002N-C

Strap Deep
 P4002N-D

Écrans / Lenses



Transparent / Cat.0 P4002Y-T

Yellow / Cat.1 P4002Y-J

Blue Mirror / Cat.2 P4002Y-M

Silver Mirror / Cat.3 P4002Y-G

Black / Cat.4 P4002Y-B

Innovity Goggle Display

PACK 12 REF. P7412
 12 masques + 12 bandeaux + 12 écrans
 12 goggles + 12 straps + 12 lenses

PACK 24 REF. P7420
 24 masques + 24 bandeaux + 24 écrans
 24 goggles + 24 straps + 24 lenses

Longueur/Length 545cm
 Largeur/Width 225cm
 Hauteur/Height 740cm



× Z ×

× AA ×





Zippy

USER FRIENDLY MAGNETIC LENSES

×AB×

×AC×

ZIPPY goggle

/ Finition brillante / Indice de protection catégorie 3. UV400
 / Monture course en polyuréthane souple qui s'adapte aux différentes formes de casques.
 / Double écran polycarbonate traité anti-buée.
 / Teinte des verres FULL REVO pour un effet miroir.
 / 3 vagues de silicone au dos de l'élastique pour une meilleure adhérence.
 / Épaisseur de la mousse 15mm. Mousse triple densité.
 / Confort et Directive Sécurité 2016/425 European Standard EN 174: 2001-Ski goggles for downhill skiing.

/ Shiny finish / Lens are 100% UV400 protection. CAT3
 / Racing shape in soft polyurethane which fits well with different types of helmets.
 / Double polycarbonate lenses with anti-fog treatment.
 / Lens treatment: FULL REVO coating.
 / 3 silicon waves at the back of the straps for a good adhesion.
 / Foam thickness 15mm. Triple density foam.
 / Comfort and security Directive 2016/425 European Standard EN 174: 2001-Ski goggles for downhill skiing.

Conçu pour les petites têtes
 Designed for small heads



Masque complet / Full goggle



Speed P6404-S
 Deliverable with Silver lens



Topo P6404-T
 Deliverable with Silver lens



Pink P6404-P
 Deliverable with Silver lens



Zebra P6404-Z
 Deliverable with Silver lens

Écrans / Lenses



Transparent / Cat.0 P5002Z-T



Yellow / Cat.1 P5002Z-J



Silver Mirror / Cat.3 P5002Z-G



Black / Cat.4 P5002Z-B

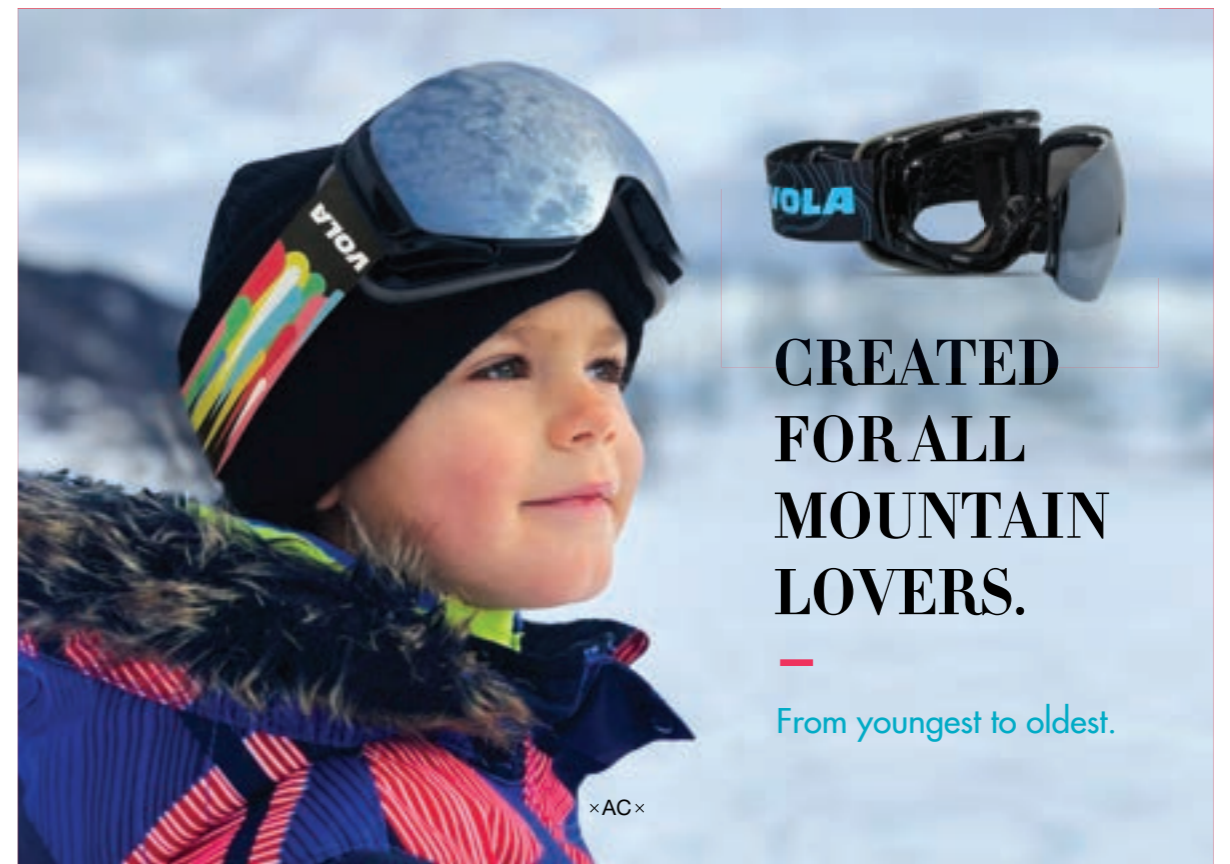

CREATED FOR ALL MOUNTAIN LOVERS.

From youngest to oldest.





20-pair capacity
Capacité de 20 paires

360° Ø 300mm

Sunglasses display
Sold without solar
Vendu sans solaire
REF. P8102



Flow Black Photochromic
P11-FP

Livré avec / Deliverable with: 







Flow Blue
P11-FB Cat.3

Livré avec / Deliverable with: 

Flow Green
P11-FG Cat.3

Livré avec / Deliverable with: 

Flow Verres supplémentaires disponibles / Additional lenses available:
   

×AD×

SUNGLASSES

/ Verres en polycarbonate. Protection UV400
/ Monture haute qualité Grilamid Optical Quality TR90
/ Livré avec sac de protection microfibre et pochette de transport.
/ Conforme aux réglementations de sécurité 2016/425,
selon la norme standard EN ISO 12312-1:2013

/ Polycarbonate lenses. UV400 Protection
/ High quality Grilamid Optical Quality TR90
/ Delivered with its microfiber bag and transport box
/ Complies with European directive 2016/425,
in accordance with EN ISO 12312-1:2013



**Summit Bi-color
Pink Black**
P11-SPB Cat.3



**Summit Bi-color
Black White**
P10-SBW Cat.3



Summit Black
P9-O Cat.3

Summit Verres supplémentaires disponibles / Additional lenses available:



Beyond Blue
P9-M Cat.3

Livré avec / Deliverable with:



Beyond Pink
P9-N Cat.3

Livré avec / Deliverable with:



Beyond Verres supplémentaires disponibles / Additional lenses available:



×AE×





Fusion Crystal
P10-FC Cat.3



Fusion Blue
P10-FB Cat.3



Active Clear
P10-AC Cat.3



Active Black
P10-AB Cat.3



Elevation Classic
P9-R Cat.3



Elevation Black
P9-Q Cat.3



Deep Ice
P11-I Cat.3



Deep Classic
P9-T Cat.3



Deep Black
P9-S Cat.3



Square Tropical
P11-T Cat.3



Square Black
P9-E Cat.3
P9-I Cat.4



MiniSquare Color
P11-MSC Cat.3



MiniSquare Black
P11-MSB Cat.3

× AF ×

× AG ×



CARBON BÂTONS POLES



SL Carbon Poles - FV2SL

Ø 12.5mm
110 / 115 / 120 / 125 / 130cm

Renfort plastique diamètre 16.5mm pour le slalom.
Shrinkage tubing diameter 16.5mm for slalom.

POIDS/WEIGHT 260g for size 125cm

GS Carbon Poles - FV2GS

Ø 12.3mm
110 / 115 / 120 / 125 / 130 / 135cm

POIDS/WEIGHT 225g for size 125cm

SL hand guard REF. F005
Protection pour bâtons slalom standard
Ø pour bâtons de 16mm à 18mm.
Standard hand guard for SL poles
Ø for poles from 16mm to 18mm.



Guards are available
for carbon & aluminium
VOLTA POLES

SL WC hand guard REF. F006
Protection pour bâtons slalom World Cup
Ø pour bâtons de 16mm à 18mm.
World Cup hand guard for SL poles
Ø for poles diameter from 16mm to 18mm.





ALUMINIUM BÂTONS POLES



SL Alu

JUNIOR REF. FV1SLJ
Ø 16mm
90/95/100/105cm

SENIOR REF. FV1SL
Ø 18mm
110/115/120/125/130/135cm



GS Alu

JUNIOR REF. FV1GSJ
Ø 16mm
90/95/100/105cm

SENIOR REF. FV1GS
Ø 18mm
110/115/120/125/130/135cm



SPEED Alu

SENIOR REF. FV790DH
Ø 18mm
120/125/130/135cm

POIDS/WEIGHT 235g for size 125cm
Aeronautic Aluminium quality 7075-T6



Trekking Alu REF. FTREK70-75

New > Alu 7075
Poignée avec mousse supplémentaire
1 petit panier + 1 grand panier + Caoutchouc
Mâts télescopiques / 3 pièces /
Réglage par Flip Lock
Longueur maxi : 135 cm
Longueur de transport : 64 cm

New > Alu 7075
Handle with extra foam
1 small basket + 1 large basket + Rubber
Telescopic poles / 3 parts /
Adjustment by Flip Lock
Max length : 135 cm
Transport Length : 64 cm



RENTAL BÂTONS POLES



NEW Design

Finition anodisée anti-rayures
Scratch-resistant anodised finish

Rental Poles ALPINE
JUNIOR = REF. FRA-JR
SENIOR = REF. FRA-SR

Alu 7075 Anodized design
JR Ø 16 mm / 80 to 105 cm
SR Ø 18 mm / 110 to 135 cm
Rondelle *Basket* 65mm

Rental Poles NORDIC
JUNIOR = REF. FNR-JR
SENIOR = REF. FNR-SR

Alu 7075
Ø 16 mm
80 to 170 cm

× AL ×

NEW

Rental Poles ALPINE - FIBER
SENIOR = REF. FFR-SR

30% Carbon 70% fiberglass
Ø 16 mm
110 to 135 cm
Rondelle *Basket* 53mm

SALES BÂTONS POLES



Sales Poles ALPINE
JUNIOR = REF. FBV-JR
SENIOR = REF. FBV-SR

Alu 6061
JR Ø 16 mm / 80 to 105 cm
SR Ø 18 mm / 110 to 135 cm
Rondelle *Basket* 65mm

× AM ×



CUSTOM



×AN×

CUSTOM BÂTONS POLES

MOQ = 500 PAIRS
AND 25 PAIRS BY SIZE



Custom Poles

MOQ 500 pairs and 25 pairs by size.
Full possibilities = trekking, alpine, nordic, etc.
Price depending of the configuration of the poles.
Fully personalised.

×AO×



INSPIRATIONS





DO IT WITH PASSION
OR NOT AT ALL
#flytosuccess



EQUIPMENT ACCESSORIES



NEW

Helmet metal display
For all VOLA helmets
REF. P8100



NEW

Goggle metal display
For all VOLA goggles
REF. P8101



Goggle Cover
Black REF. P8000-B
Wheel REF. P8000-W
Vola REF. P8000-V



EVA case goggles/lenses
REF. P80001
Largeur/Width 9 Longueur/Length 20 Hauteur/Height 12cm



Soft lens bag
REF. P80002



Ski poles bag
REF. F1000

Capacité maximum de 15 paires.
Maximum capacity of 15 pairs.
Maximale Kapazität von 15 Paaren.
Capacità massima di 15 paia.

Size Longueur/Length = 135cm Ø = 22cm